

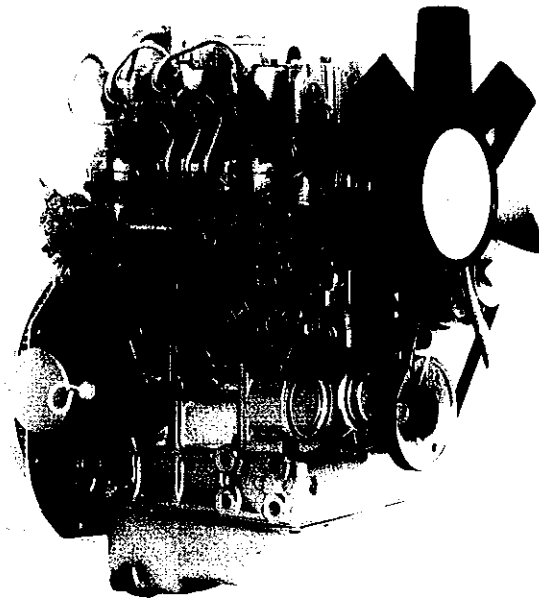

# Workshop Manual



## **100 Series**

102-04, 103-06, 103-09

## **Perama**

M20, M25, M30

**workshop  
manual for  
PERKINS 100 SERIES  
102-04/102-05/103-06/  
103-07/103-09/103-10  
PERAMA M20/M25/M30**

*This publication is written for worldwide use. In territories where legal requirements govern engine smoke emission, noise, safety factors, etc., then all instructions, data and dimensions given must be applied in such a way that, after servicing (preventive maintenance) or repairing the engine, it does not contravene the local regulations when in use.*

# CONTENTS

	PAGE
ABBREVIATIONS and CODES .....	4
FOREWORD .....	5
SAFETY PRECAUTIONS .....	6
ENGINE PHOTOGRAPHS .....	7
SECTION I	
Description .....	1-1
SECTION II	
General Engine Data .....	2-1
SECTION III	
Dismantling Sequence .....	3-1
SECTION IV	
Disassembly, inspection, fits and clearances of component assemblies .....	4-1
Rocker Arm and Lever .....	4-1
Cylinder Head and Valves .....	4-2
Valve Guide and Seats .....	4-3
Piston .....	4-6
Piston Ring .....	6
Piston Rod .....	4-9
Oil Running Clearance .....	4-9
Main Bearing .....	4-11
Crankshaft .....	4-12
Crankshaft Rectification .....	4-13
Flywheel and Ring Gear .....	4-15
Camshaft .....	4-15
Timing Gear .....	4-16
Oil Pump .....	4-16
Oil Filter .....	4-17
Water Pump .....	4-17
Thermostat .....	4-17
Radiator .....	4-18
Fuel Filter .....	4-18
Fuel Lift Pump .....	4-18
Governor .....	4-19
Atomizers .....	4-20
Air Cleaner .....	4-21
SECTION V	
Reassembly .....	5-1
Timing .....	5-4
SECTION VI	
Electrical Systems .....	6-1
Alternator .....	6-1
Starter .....	6-5
Troubleshooting .....	6-8
Glow Plug .....	6-9
Thermoswitch .....	6-9
Oil Pressure Switch .....	6-9
Wiring Diagrams .....	6-11
SECTION VII	
Troubleshooting .....	7-1
SECTION VIII	
Service Standards .....	8-1
SECTION IX	
Recommended Torque Settings .....	9-1
SECTION X	
Perama Supplement .....	10-1
SECTION XI	
Conversion Formulas .....	11-1

## Abbreviations and codes

### Engine Build List (Parts List) Numbering System

The standard engine parts list numbering code system is defined as follows:

Code	I	II	III	IV	V
Example:	KC	30226	J	000001	M

#### Code I Engine Type

KA = 102-04  
 KN = 102-05  
 KB = 103-06/PERAMA M20  
 KL = 103-07  
 KC = 103-09/PERAMA M25  
 KD = 103-10/PERAMA M30

#### Code II Engine Parts List

Parts list increases numerically for both OEMS and distributors.

#### Code III Country of Manufacture

J = Made in Japan

#### Code IV Engine Serial Number

Individual engine serial number commencing with 000001 increasing numerically

#### Code V Year of Manufacture

M = 1985  
 N = 1986  
 O is Omitted  
 P = 1987  
 Q/S = 1988  
 T = 1989  
 U = 1990  
 V = 1991  
 W = 1992  
 X = 1993  
 Y = 1994  
 A = 1995  
 B = 1996  
 C = 1997

# FOREWORD

This Workshop Manual has been compiled for use in conjunction with normal workshop practice. Mention of certain accepted practices, therefore, has been purposely omitted in order to avoid repetition.

Reference to renewing joints and cleaning off joint faces, has to a great extent been omitted from the text, it being understood that this will be carried out where applicable. Similarly, it is understood that in reassembly and inspection, all parts are to be thoroughly cleaned, and where present, burrs and scale are to be removed. It follows that any open ports of high precision components, e.g. fuel injection equipment, exposed by dismantling, will be blanked off until reassembled, to prevent the ingress of foreign matter.

When fitting setscrews into "through" holes into the interior of the engine, a suitable sealant should be used.

Throughout this manual, whenever the "left" or "right" hand side of the engine is referred to, it is that side of the engine when viewed from the flywheel end.



# Safety Precautions



THESE SAFETY PRECAUTIONS ARE MOST IMPORTANT. Reference must also be made to the local regulations in the country of operation.

Do not use these engines in marine applications (Except Perama versions).

Do not change the specification of the engine.

Do not smoke when you put fuel in the tank.

Clean away any fuel which has spilled and move material which has fuel contamination to a safe place.

Do not put fuel in the tank during engine operation (unless absolutely necessary).

Never clean, lubricate or adjust the engine during operation (unless you have had the correct training when extreme caution must be used to prevent injury).

Do not make any adjustments you do not understand.

Ensure the engine is not in a position to cause a concentration of toxic emissions.

Persons in the area must be kept clear during engine and equipment or vehicle operation.

Do not permit loose clothing or long hair near parts which move.

Keep away from parts which turn during operation. Note that fans cannot be seen clearly while the engine is running.

Do not run the engine with any safety guards removed.

Do not remove the radiator cap while the engine is hot and the coolant is under pressure as dangerous hot coolant can be discharged.

Do not use salt water in the fresh water cooling system or any other coolant which can cause corrosion.

Keep sparks or fire away from batteries (especially while during charge) or combustion can occur. The battery fluid can burn and is also dangerous to the skin and especially the eyes.

Disconnect the battery terminals before you make a repair to the electrical system.

Only one person must be in control of the engine.

Ensure the engine is only operated from the control panel or operators position.

If your skin comes into contact with high pressure fuel, get medical assistance immediately.

Diesel fuel and used engine oils can cause skin damage to some persons. Use protection on the hands (gloves or special skin protection solutions).

Do not move equipment unless the brakes are in good condition.

Ensure that the transmission drive control is in "Neutral" position before the engine is started.

Fit only genuine Perkins Parts.

Do not use ether to start these engines.

# ENGINE DIAGRAMS

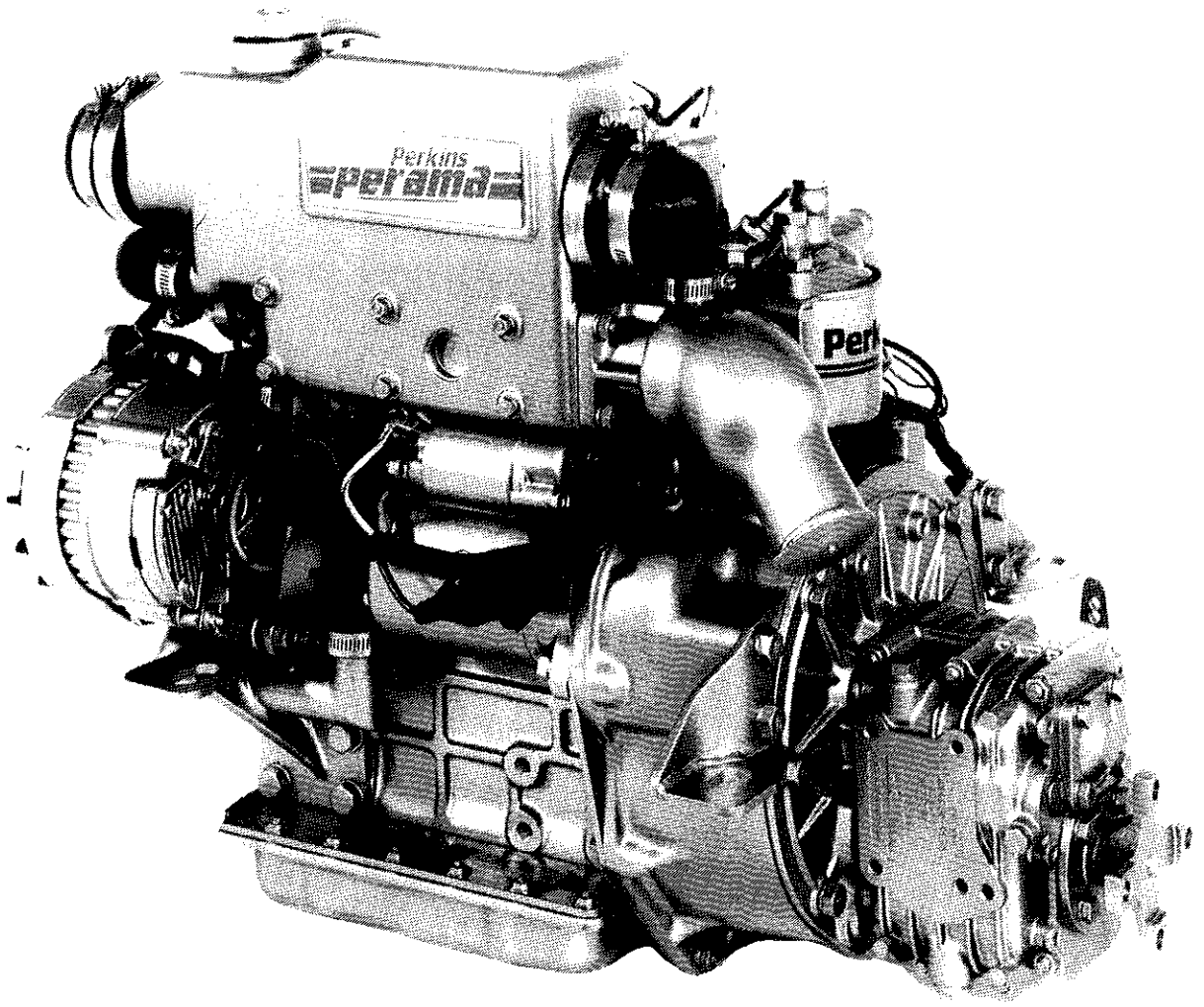

# Engine cross sectional views

PB002

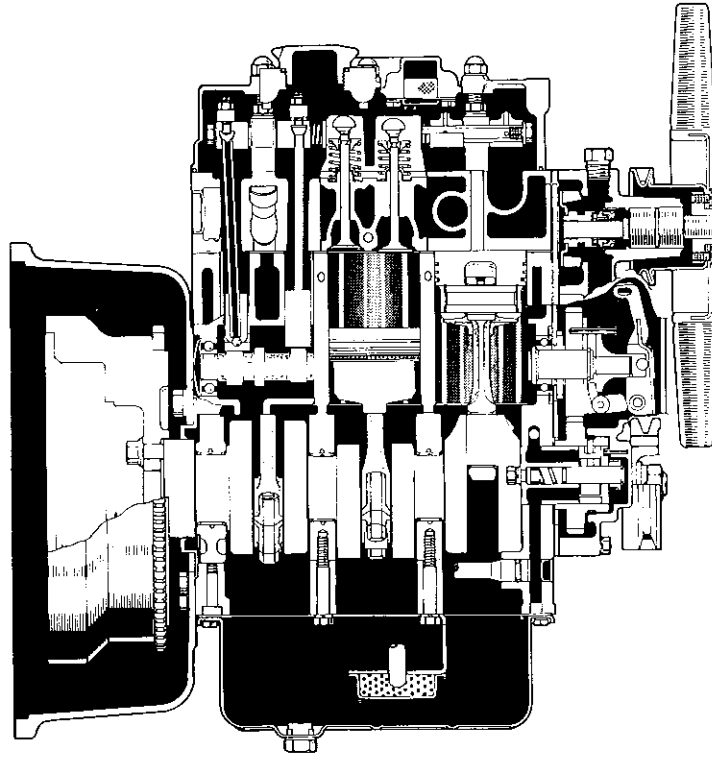

PB003

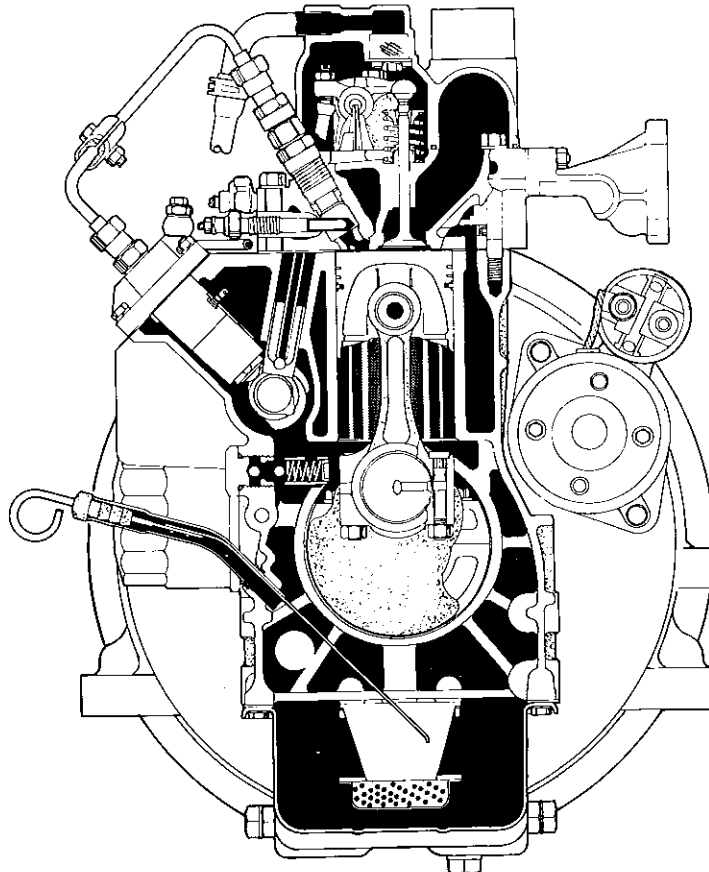



# SECTION I

## Perkins 100 Series: 102-04/102-05/ 103-06/103-07/103-09/103-10

### Perama: M20/M25/M30

#### DESCRIPTION; GENERAL

The Perkins 100 Series is a three cylinder four stroke, liquid cooled, compression ignition engine, designed for durability, low weight and compactness. The linerless cylinder block, three-piece helical gear train and flange mounted fuel injection pump on the engine cam, reduce frictional power loss, and engine weight. The special swirl pre-combustion chamber along with the small bore multi-cylinder design offers good fuel consumption, low noise and excellent startability.

The Perkins 100 Series offers easy maintenance with all service items on the right hand side of engine.

#### DESCRIPTION; COMPONENT ASSEMBLY

##### Cylinder Block:

The cylinder block is made from high grade cast iron with copper and chrome additives and is integral with the crankcase. The crankcase features four main bearings of the tunnel block design, with crankcase walls extending well below the crankshaft centre line for strength and rigidity. The cylinder bores are plateau honed for oil retention and extended ring life. The non-machined surfaces are sealed to ensure cleanliness.

##### Crankshaft:

The crankshaft is a chrome-molybdenum steel forging, fully machined, static and dynamically balanced with integral counterweights. All bearing surfaces are induction hardened. The axial location is by thrust washers at number four main bearing. The four main journals run in replaceable steel-backed cast copper/lead alloy bearings. The front of the crankshaft is keyed.

##### Pistons and Connecting Rods:

Pistons are cast from high silicon aluminium alloy and are heat treated for low weight with high strength and good thermal conductivity. The piston is fitted with three rings; two cast iron, chrome-faced compression rings and one steel, chrome-faced controlled oil ring. The

fully floating gudgeon pin (wrist pin) is made of chrome molybdenum steel alloy hardened by carburizing and retained by the conventional circlip method. The connecting rods are machined from high strength forged steel. The big end bearings are renewable steel-backed, copper/lead alloy overlay with tin plating. The small end bearings are a press fit plain bush of tin-backed lead/bronze.

##### Camshaft:

The camshaft is made of forged steel and is induction hardened. Three additional lobes at the front operate the fuel injection pump. At the rear a fuel lift pump eccentric is machined. The camshaft is supported by roller and needle bearings and lubricated by splash feed. The nose of the camshaft supports the tachometer drive, cam gear, governor weight cage and governor slider assembly.

##### Cylinder Head:

The cylinder head is made of high grade copper chrome cast iron. Lower speed engines have valve seats machined into the cylinder head, higher speed engines incorporate replaceable heat resistant alloy steel valve seats. Inlet and exhaust valves are made of high grade heat resistant alloy steel with tufrided stems and induction hardened heads. Each stem is fitted with a chrome molybdenum steel cap for long life.

The valves are operated by cold drawn seamless tube pushrods with hardened steel ball and forged cup ends. Flat based tappets are made from case carburized chrome molybdenum steel operating in machined bores in the cylinder block. The rocker shaft is an induction hardened hollow steel tube. Valve clearances are adjusted by hardened ball ended screws and locknuts.

##### Rocker Cover:

The cover is made of cast aluminium with an integral air intake, oil filler and crankcase breather. It is located in position by rocker pillar studs and secured by cap nuts.

**Gear Train:**

The gear train consists of three helical gears; the crankshaft gear, located by a woodruff key. The idler gear houses the lube oil pump and the cam gear incorporates the governor weight cage.

**Fuel System:**

A flange mounted, Bosch type fuel injection pump is mounted in the cylinder block and operated by lobes machined on the engine cam. The fuel lift pump is located on the right-hand side of the cylinder block and also operated by the engine camshaft.

**Lubricating System:**

A trochoid lobe type oil pump located in the centre of the idler gear sends lubricating oil to the main oil galley via a relief valve through a spin-on bypass oil filter to the main oil galley. The rockers are pressure fed via an externally mounted oil pipe, from the main oil gallery to the cylinder head.

**Cooling System:**

A belt driven centrifugal water pump circulates coolant via the internal water passages. The coolant is radiator-cooled and temperature controlled by a conventional thermostat.

# SECTION II

## General Engine Data

	102-04	102-05	103-06	103-07	103-09	103-10
Type Vertical in line .....	2 Cyl.		3 Cyl.			
Basic Thread and Size .....	Metric					
Bore .....	64	67	64	67	72	75
Stroke .....	64	64	64	64	72	72
Combustion System .....	I.D.I SPECIAL SWIRL					
Compression Ratio .....	23:1	24:1	23.5:1	24:1	24:1	23:1
Swept volume litre .....	0.411	0.451	0.617	0.676	0.879	0.954
Firing Order .....	1-2		1-2-3			
Rotation .....	Anti-clockwise viewed from flywheel					
Injection Pump .....	Flange mounted, Bosch type plunger and barrel					
Injectors .....	Bosch type throttle					
Injector Setting .....	Working			Setting		
Kilograms/sq.cm (kg/cm <sup>2</sup> ) .....	115-125			125-130		
Atmospheres .....	111-121			121-126		
Pounds per sq.inch (PSI) .....	1636-1778			1778-1850		
Governor .....	Mechanical all speed					
Cooling system .....	Liquid with water pump and radiator					
Industrial Cooling System Capacity (less radiator) .....	0.98	1.3		1.7		
Perama M20/M25/M30 Cooling System Capacity .....	3.0	4.0		4.0		
Thermostat Operating Temperature (°C) .....	73° to 87°				80° to 95°	
Lubricating System .....	Pressure feed with Trochoid pump					
Lubricating Oil Capacity MAX (including filter) .....	2.1	2.8		3.5		
	(PERAMAM20 3.0l)		(PERAMA M25/ M30 4.3l)			
Oil Pressure Relief .....	42-71 PSI					
Oil Pressure Switch .....	4.3 PSI					
Electrical System .....						
Starter .....	12v					
Alternator .....	12v					
Battery 12v .....	45 AH min			70 AH min		
Weight, Bare Engine (Industrial) .....	51	64		83		
Height .....	489	489		540		
Length F/F .....	369	442		490		
Width .....	390	390		410		
Min. Idle Speeds .....	1200		800		950	
Perama M20/ M25/M30 .....			900		950	
Hurth HBW 50 Reverse Gearbox Oil Capacity .....			0.30 l			
HBW 100 Gearbox Oil Capacity .....			0.35 l			

Recommended Engine Fluids

Coolant .....

Clean soft water. Maximum antifreeze concentration 50% (ethanediol base – ethylene glycol with corrosion inhibitor to BS 6850:1985 or ASTM D3306-74 or AS 2108-1977)

Fuel .....

Cetane number – 45 minimum  
 Viscosity – 2.5/4.5 centistokes at 40°C  
 Density – 0.835/0.855 kg/litre  
 Sulphur – 0.5% of mass maximum  
 Distillation 85% at 350°C  
 (Aviation fuel JP4 is not recommended, however JP5 and JET-A are acceptable providing 5% spindle oil added)

Lubricating oil

Lubricating oil specification

Engine type	Specifications	
	API CC/SE MIL - L - 46152 CCMCD1	API CD/SE MIL - L - 2104C CCMCD2
Naturally aspirated	•	•(1)

(1) Not recommended during the first 20/50 hours of operation

Recommended SAE viscosity grades

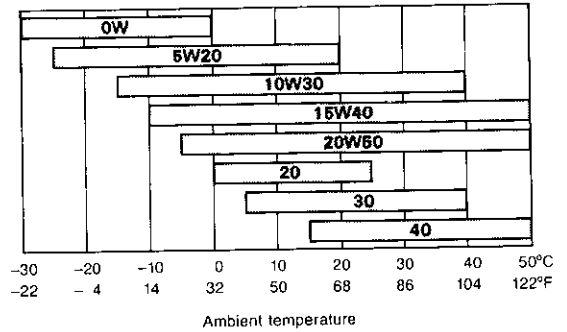

NB: Ensure correct fluids are used and oil and coolant are filled SLOWLY and to the correct quantities.

**Hurth Gearbox Oil:** Automatic transmission fluid ATF Type 'A'.

# SECTION III

## Dismantling Sequence

### Alternator

- A. Remove alternator and adjusting bracket.

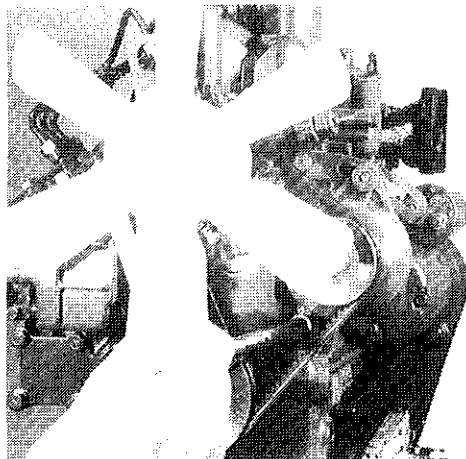

PB004

### Rocker Cover

- A. Remove breather hose. Loosen and remove three cap nuts with washers. Lift rocker cover assembly.

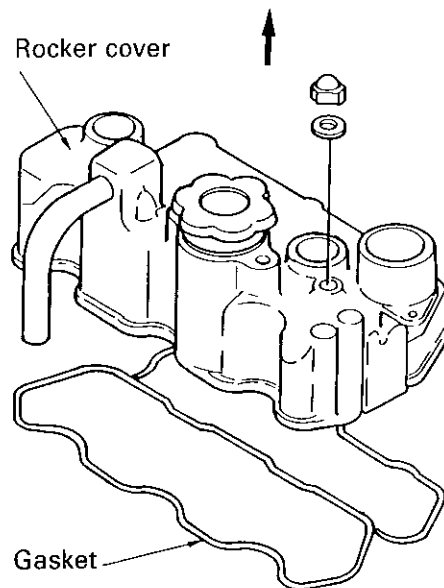

E0005

### Remove Cooling Fan and Pulley

### Fuel Injection Pipe

- A. Loosen fuel pipe nuts from fuel injection pump and injectors. Remove pipes as an assembly.  
B. Remove spring clamp and fuel return hose.

### Atomizer Assembly

- A. Loosen and remove three securing nuts. Remove leak-off rail. Remove three aluminium washers and discard. Remove atomizers.

### Contact Switches

- A. Remove water and oil sender units.

### Water Pump Assembly

- A. Loosen securing bolts and remove water pump assembly and set plate.

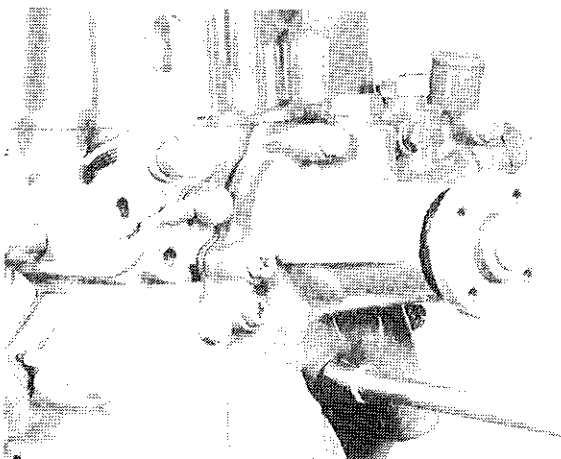

PB005

### Rocker Assembly

- A. Loosen and remove three nuts, lock washers and flat washers from rocker pillar stud. Lift rocker assembly.  
B. Remove push rods, and valve stem caps.

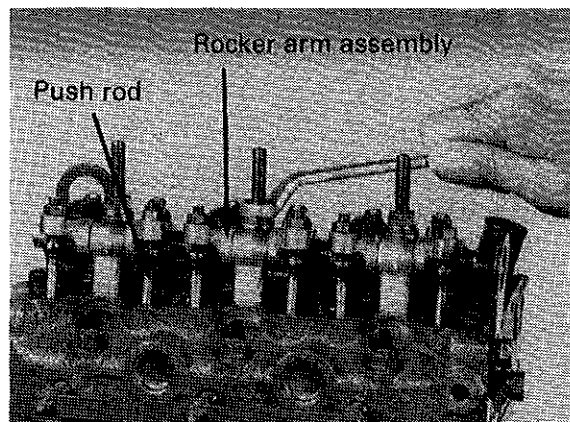

PB007

### External Oil Pipe

- A. Loosen and remove two banjo bolts at cylinder block main oil galley and cylinder head assembly.
- B. Remove clamp from fuel injection pump.

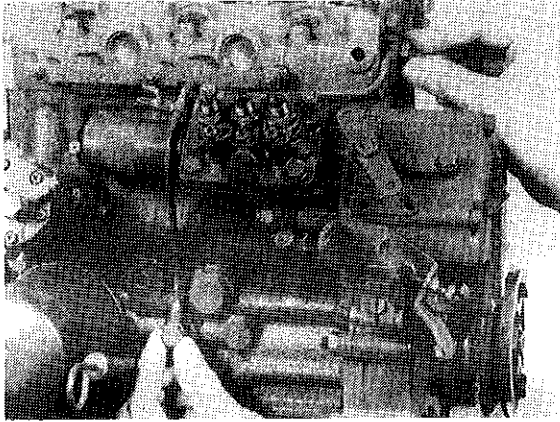

PB008

### Fuel Lift Pump

- A. Loosen two cap screws and lift from its bore; remove joint.

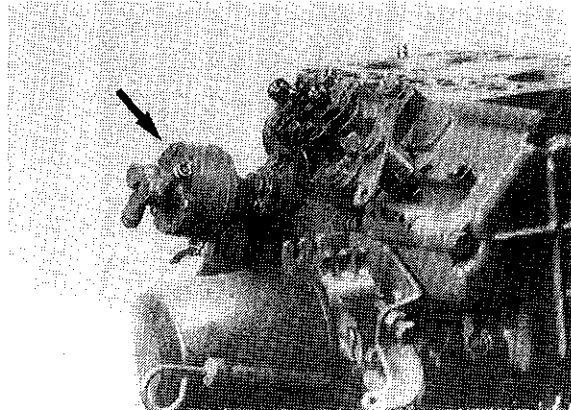

PB011

### Cylinder Head Assembly

- A. Loosen cylinder head bolts starting from the centre, in a circular pattern using several steps of equal torque. Remove head.

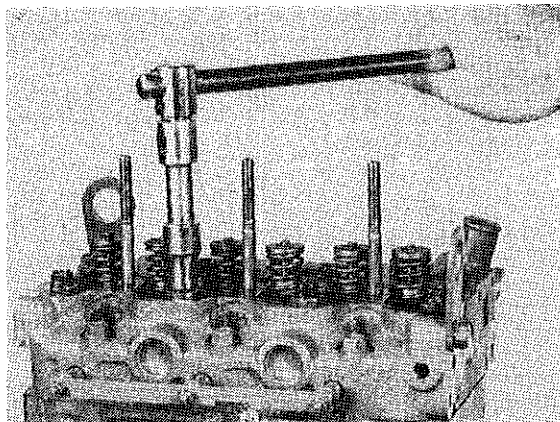

PB009

### Fuel Injection Pump Assembly

- A. Remove two bolts and nuts securing fuel injection pump to cylinder block. Slowly lift and position fuel injection pump until access to link snap pin is gained.
- B. Remove snap pin and remove link from control rack. Remove fuel injection pump and shim pack.

NOTE: Injection timing is determined by the shim pack between fuel injection pump flange and cylinder block mounting face. The thickness and number of shims should be checked and recorded to aid re-assembly.

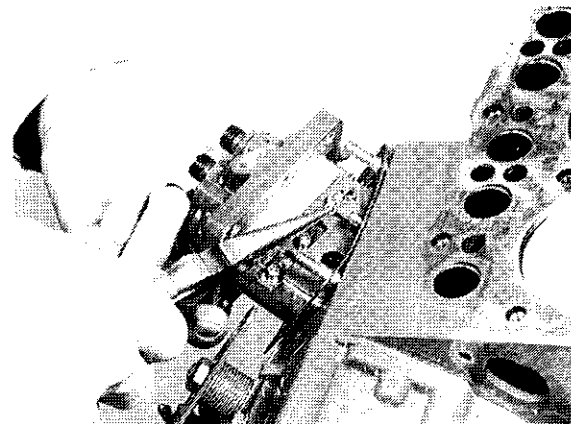

PB012

### Tappets

- A. Pull tappets from the machined bores in cylinder block.

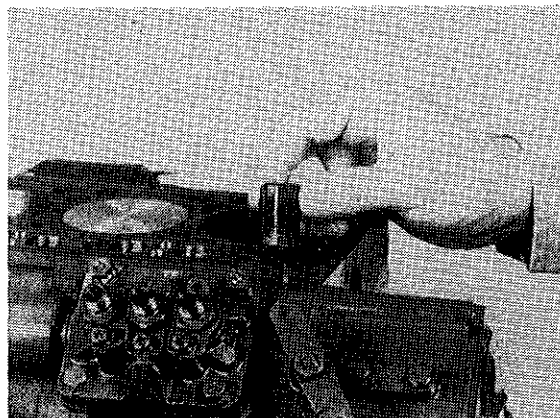

PB010

### Crank Pulley

- A. Loosen pulley nut and remove pulley.

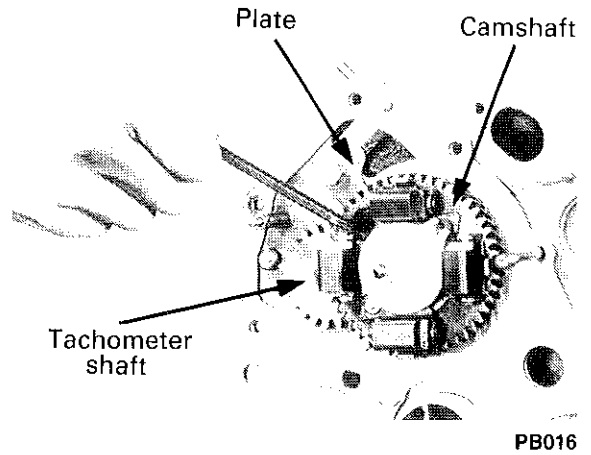
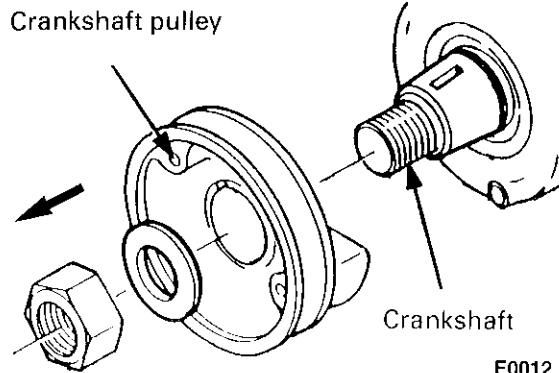

### Front End Plate Assembly

- A. Remove retaining bolts and lift front plate off its locating dowels. Remove joint and discard.

### Oil Filter

- A. Remove spin-on type oil filter and discard.

### Gear Cover and Governor Assembly

- A. Remove securing bolts and lift cover assembly off the locating dowels.

### Idler Gear and Oil Pump Assembly

- A. Remove circlip. Remove entire assembly.

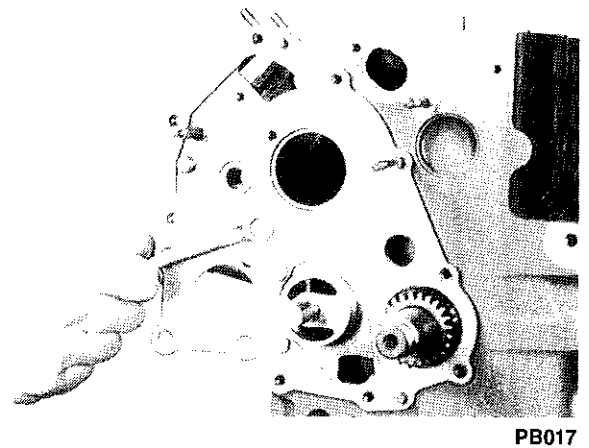
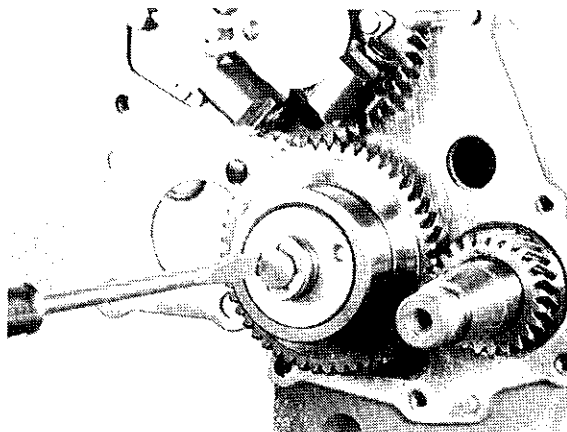

### Dipstick Assembly

- A. Loosen fixing bolt and remove assembly.

### Oil Sump

- A. Remove all bolts, lower sump and discard joint.

### Suction Pipe and Strainer

- A. Remove two securing bolts. Rotate suction pipe out of its bore.

### Camshaft Assembly, Tachometer Drive

- A. Using access hole in cam gear, remove keeper plate.
- B. Slide cam shaft with fly weight retainer out of camshaft bore.
- C. Pull tachometer drive shaft from its bore.

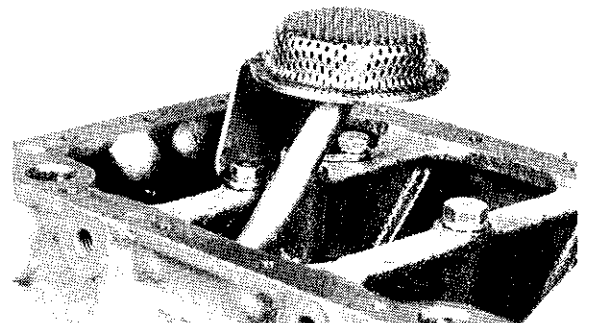

### Connecting Rod and Piston

- A. Loosen connecting rod nuts and remove rod cap.
- B. Remove carbon from cylinder bore. Push piston and connecting rod through cylinder block. Replace rod cap to piston assembly.

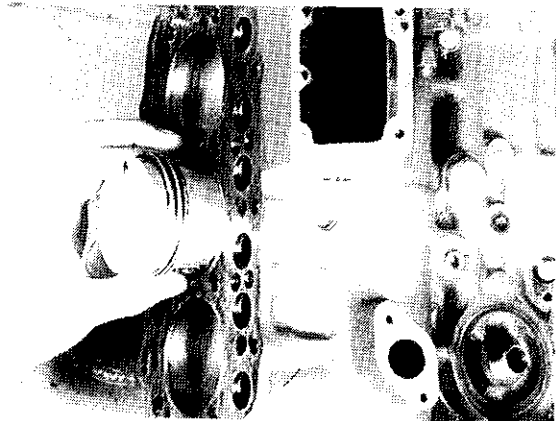

PB020

### Remove Oil Seal

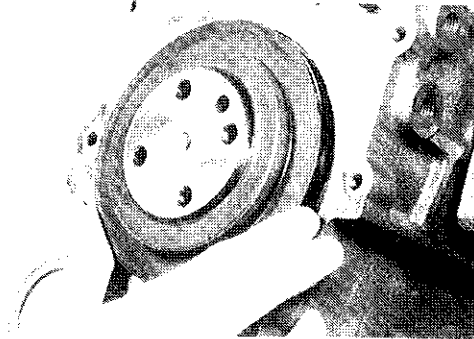

PB022

### Crankshaft and Main Bearing Assembly

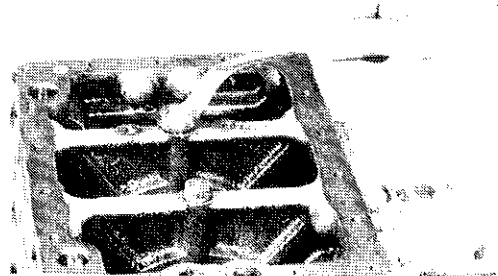

PB023

### Flywheel Assembly

- A. Loosen bolts, remove flywheel.

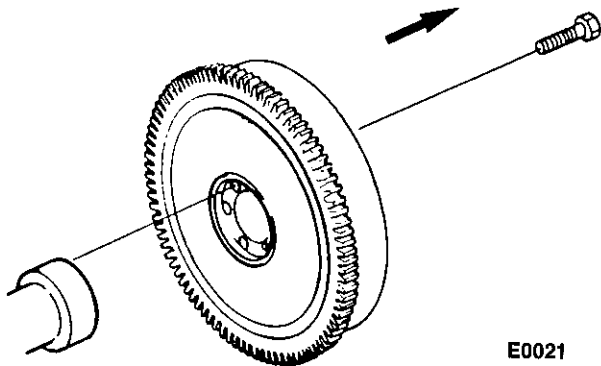

E0021

- A. Remove bolts fitted through crankcase cross members.
- B. Slide out crankshaft and main bearing assembly.

### Remove Relief Valve Assembly

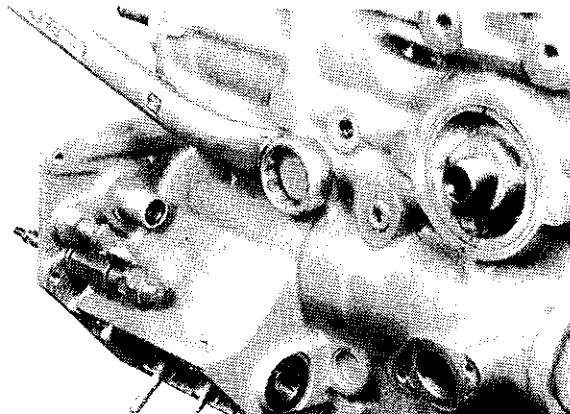

PB024

### Back Plate

- A. Loosen two starter retaining nuts; remove starter.
- B. Loosen back plate retaining bolts and remove back plate.



# SECTION IV

## Disassembly, inspection, fits and clearances of component assemblies

### Rocker Arm Assembly

#### - Disassembly

- A. Remove the bolt at the rocker arm shaft end.
- B. Pull out the pin located in No. 1 cylinder rocker arm bracket.
- C. Pull out the rocker arm, spring and bracket.

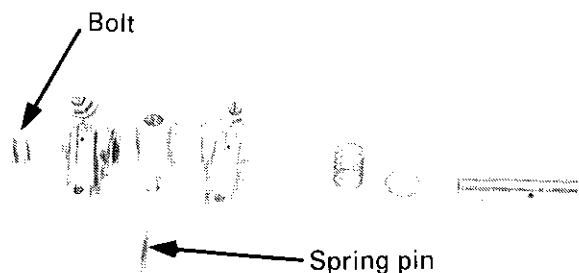

PB025

Standard Clearance	Allowable limit
0.032-0.068mm (.001-.026")	0.2mm (.008")

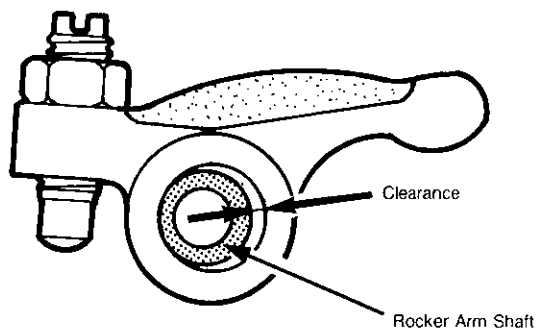

E0027

#### - Inspection and Correction

- A. Wear of rocker arm shaft

Using a micrometer, check outside diameter of the rocker arm shaft. If the rocker arm shaft is worn beyond allowable limit, replace.

Standard dimension	Allowable limit
11.65-11.67mm (.459-.460")	11.57mm (.456")

- C. Wear on valve stem contact face of the rocker arm.

Check the face for step wear or score. Slight wear may be corrected using an oil stone.

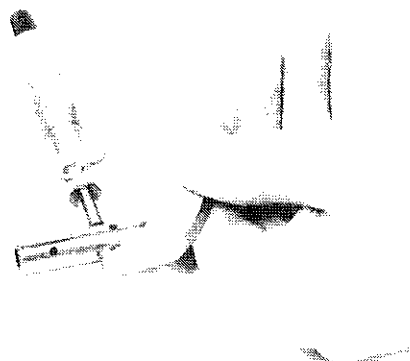

PB026

### Cylinder Head Assembly

- A. Using a valve spring replacer, compress the valve spring to remove the valve collets, retainer, spring and valve.

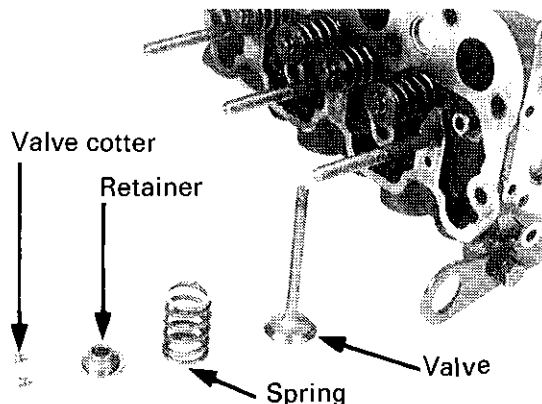

PB028

- B. Rocker arm-to-shaft clearance

Measure the inside diameter of the rocker arm. Calculate the clearance between the rocker arm and rocker arm shaft. If the clearance is excessive, replace.

**- Inspection and Correction**

**A. Cylinder head**

With a straight edge and a thickness gauge, check for warping of the cylinder head lower face.

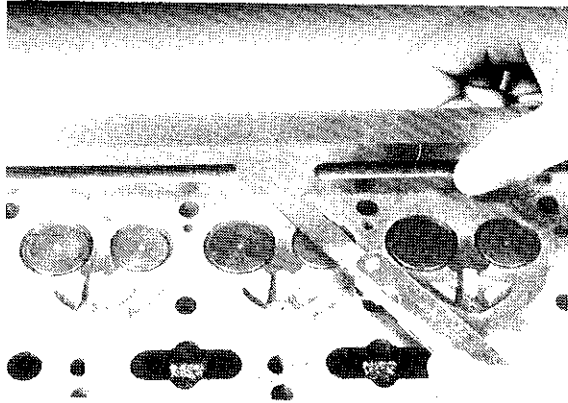

PB029

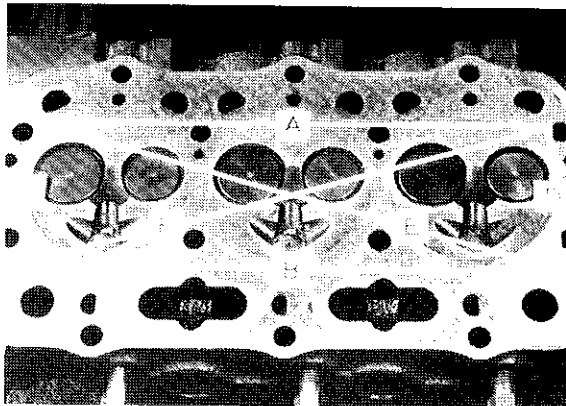

PB030

Check six positions (A to F lines, as shown) for warping. If found to be warped excessively, correct with a surface grinder.

Standard value	Allowable limit
0.05mm or less (.002")	0.12mm (.005")

**B. Valve guide and valve stem**

- a. Check the valve stem for excessive wear or damage. If found to be excessively damaged, replace.
- b. Check valve stem diameters at positions I, II and III with a micrometer. If the diameter is less than allowable limit, replace.

**Intake valve 103-09/10/Perama M25/M30**

Standard diameter	Allowable limit
6.955-6.97mm (.274")	6.89mm (.271")

**Intake valve 102-04,102-05,103-06,103-07, M20**

Standard diameter	Allowable limit
5.960-5.975mm (.2346-.2352")	5.9mm (.2323")

**Exhaust valve 103-09/10/Perama M25/M30**

Standard diameter	Allowable limit
6.94-6.95mm (.274")	6.84mm (.269")

**Exhaust valve 102-04,102-05,103-06,103-07,M20**

Standard diameter	Allowable limit
5.940-5.955mm (.2339-.2344")	5.9mm (.2323")

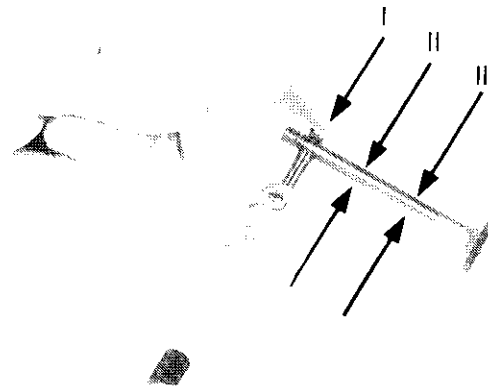

PB031

**c. Thickness of valve head**

If valve head thickness is less than allowable limit, replace valve.

Standard thickness	Allowable limit
0.925-1.075mm (.036"-0.042")	0.5mm (.020")

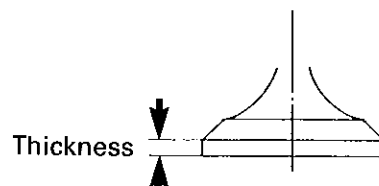

PB127

d. Valve to valve-guide clearance

Check the clearance between the valve and valve guide. If the clearance exceeds the allowable limit, replace.

Intake valve

Standard clearance	Allowable limit
0.025-0.052mm (.001-.002")	more than 0.2mm (.008")

Exhaust valve

Standard clearance	Allowable limit
0.045-0.072mm (.0018-.0028")	more than 0.25mm (.010")

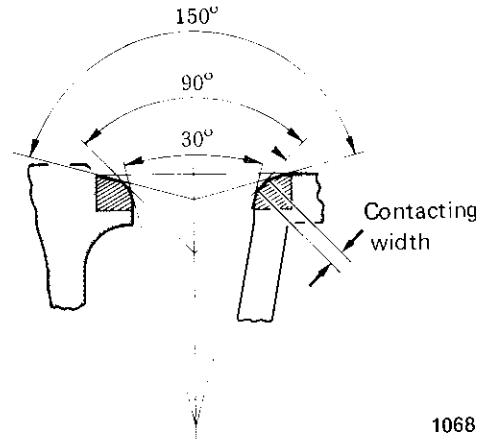

1068

b. Recess of valve seat

If the recess is more than allowable limit, replace the valve seat (if fitted).

103-09/10/Perama M25/M30

Standard recess	Allowable limit
0.85-1.15mm (.034-.045")	1.8mm (.071")

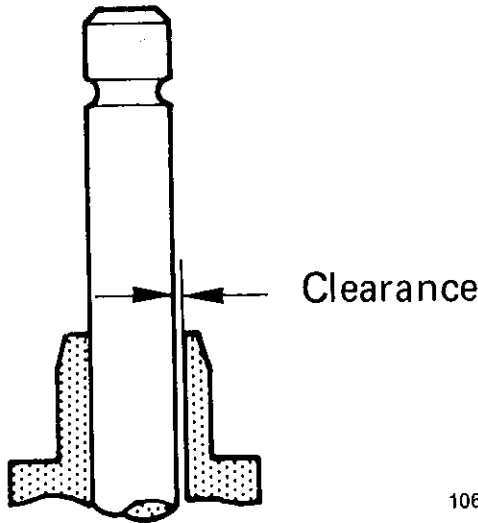

1067

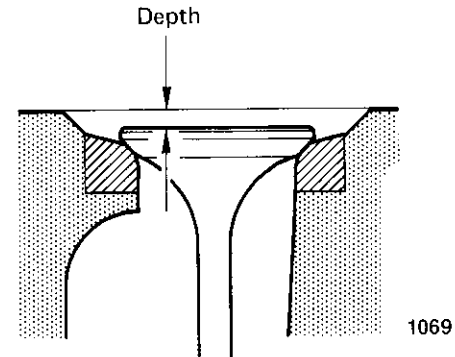

1069

c. Valve seat

a. Valve seat contact width

If the contact width of the valve seat is more than allowable width, check wear condition of the valve guide first.

Using the seat cutters of 15° 45° and 75° correct the seat.

103-09/10/Perama M25/M30

Standard width	Allowable limit
1.7-2.1mm (.067-.082")	2.5mm (.098")

102-04,102-05,103-06,103-07, M20

Standard width	Allowable limit
1.59-1.80mm (.0626-.0709")	2.5mm (.098")

102-04,102-05,103-06,103-07, M20

Standard recess	Allowable limit
0.70-0.90mm (.0276-.0354")	1.8mm (.071")

Replacement of valve seat insert (where fitted):

Either 1. Using gas burner (700 to 800°C), heat diagonally across the valve seat insert. Leave in air for 3 to 5 minutes and remove the valve seat insert by light tapping (ensuring the head is not damaged).

Or 2. Machine the insert out taking care not to damage the head.

Clean up the insert bore and fit new insert using a press (1,000 to 1,500kgf) and a suitable smooth surface tool. To assist process, chill the valve seat insert with liquid nitrogen etc or heat the head to between 60 and 100°C.

c. Lapping of contact face of the valve seat

Correct valve seat contact using a valve lapper and lapping compound.

When using a new cylinder head, obtain correct seat contact width and seat recess using the seat cutter. Then, carry out lapping.

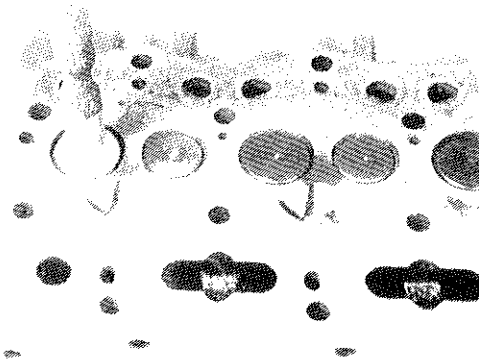

PB036

D. Valve spring

Visually inspect the valve spring for damage.

Position the valve spring on a flat surface and check the squareness of it using a square, as shown in the illustration. If it exceeds allowable limit, replace the spring.

Using a spring tester, check spring force and free length.

Replace if found to be beyond allowable limit.

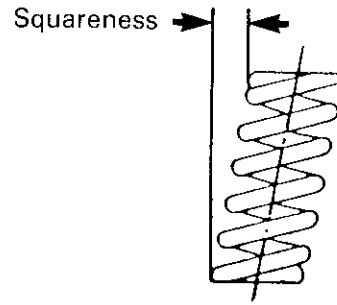

PB128

E. Inner face of combustion chamber

Pull out the cap and insert from the cylinder head. Check and clean the combustion chamber.

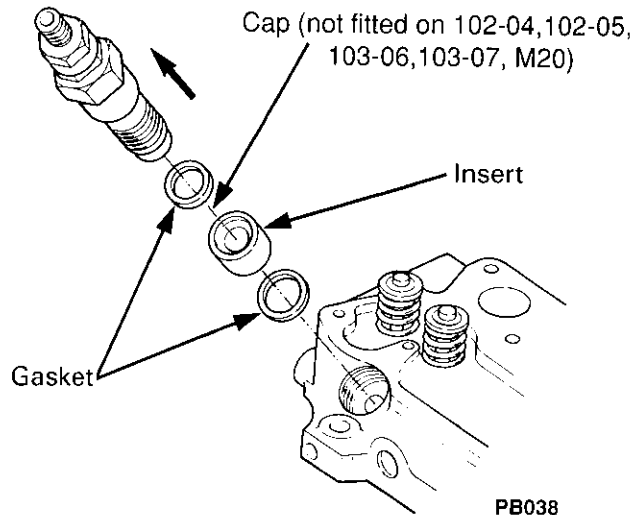

PB038

103-09/10/Perama M25/M30

	Standard value	Allowable limit
Squareness (mm)	(1.2) .047"	(2.0) .079"
Free length (mm)	(35) 1.378"	(33.5) 1.319"
Spring force (kg) (when compressed to 30.4mm 1.197")	(8.1) 17.9 lbf	(7) 15.4 lbf

102-04, 102-05, 103-06, 103-07, M20

	Standard value	Allowable limit
Squareness (mm)	(1.0) .039"	(1.2) .047"
Free length (mm)	(33) 1.299"	(31.5) 1.240"
Spring force (kg) (when compressed to 28.3mm)	(6.9) 15.2 lbf	(6.0) 13.2 lbf

- Reassembly

Reassemble the parts in the reverse order of disassembly.

NOTE: When assembling the valve spring, retainer and collets, take care not to damage the valve guide seal.

Cylinder block

- Inspection and Correction

A. Cylinder block top face

Inspect the cylinder block top face for cracks, damage and warping in the same way as for the cylinder head.

If outside limit, replace cylinder block.

Standard value	Allowable limit
Less than 0.05mm (.002")	0.12mm (.005")

B. Cylinder bore

- a. Visually inspect cylinder bore. There should be no scoring, rust or corrosion.
- b. Measure the cylinder bore at the upper, middle and lower areas (Piston ring contact area) in the direction of the crankshaft (A direction) and at right angle to the crankshaft (B direction).

The upper area described in the above (b) corresponds to the top ring when the piston is at the T.D.C., (about 10mm below the cylinder block top surface). The lower area corresponds to the piston oil ring when the piston is at the B.D.C. (about 100mm from top face).

Check the bore using a cylinder gauge.

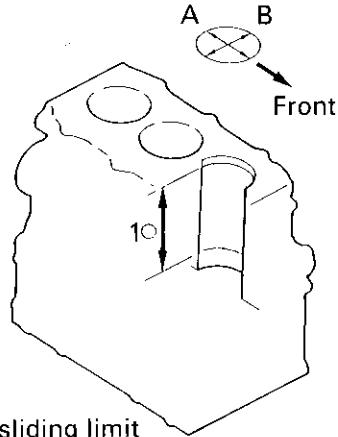

1 Ring sliding limit

PG044

- c. If the bore is found to be outside allowable limit, re-bore to the oversize dimension as shown.

Grinding stone size: 100L x 4W  
 Speed: 162 rpm  
 Feed (shaft direction): 13 m/min  
 Gauge pressure:  
     15 kg/cm<sup>2</sup> (5 kg/cm<sup>2</sup> – finish)  
 Finish stroke: 9  
 Honing depth: 0.04mm (diameter)  
 Cross hatch angle: 40°  
 Surface roughness: 2-4 micron

Bore spec 102-04, 103-06, M20

Standard bore	Allowable limit
64-64.019mm (2.5197-2.5204")	64.2mm (2.5276")

Bore spec 102-05, 103-07

Standard bore	Allowable limit
67-67.019 mm	67.2mm

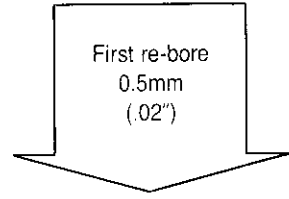

ENG TYPE	New standard bore	Allowable limit
102-04	64.5-64.519mm	64.7mm
103-06 M20	(2.5394-2.5401")	(2.5472")
102-05	67.5-67.519mm	67.7mm
103-07	(2.6575-2.6582")	(2.6653")

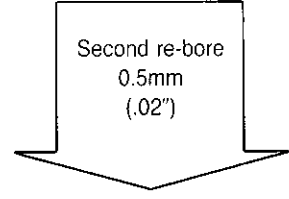

ENG TYPE	New standard bore	Allowable limit
102-04	65-65.019mm	65.2mm
103-06 M20	(2.5591-2.5598")	(2.5669")
102-05	68-68.019mm	68.2mm
103-07	(2.6771-2.6779")	(2.6850")

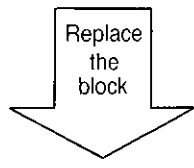

Bore spec 103-09/Perama M25

Standard bore	Allowable limit
71.99-72.005mm (2.8342-2.8348")	72.2mm (2.8425")

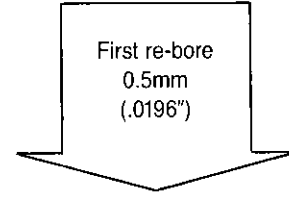

New standard bore	Allowable limit
72.49-72.505mm (2.8539-2.8545")	72.7mm (2.8621")

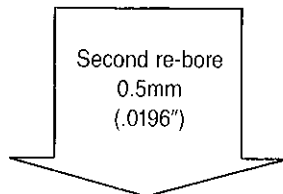

New standard bore	Allowable limit
72.99-73.005mm (2.8736-2.8742")	73.2mm (2.8818")

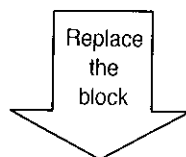

Bore spec 103-10/Perama M30

Standard bore	Allowable limit
75-75.019mm (2.9527-2.9534")	75.2mm (2.9606")

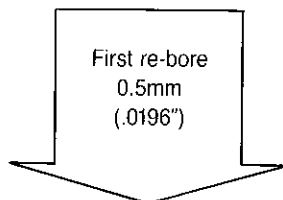

New standard bore	Allowable limit
75.5-75.519mm (2.9724-2.9731")	75.7mm (2.9803")

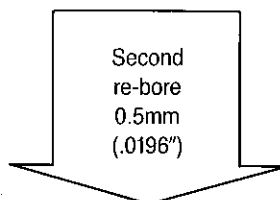

New standard bore	Allowable limit
76-76.019mm (2.9921-2.9928")	76.2mm (2.9999")

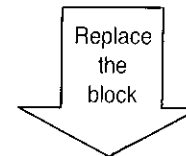

### Piston and piston rings

#### - Disassembly

- A. Remove piston rings using a piston ring tool.
- B. Remove the circlip and extract the gudgeon pin.

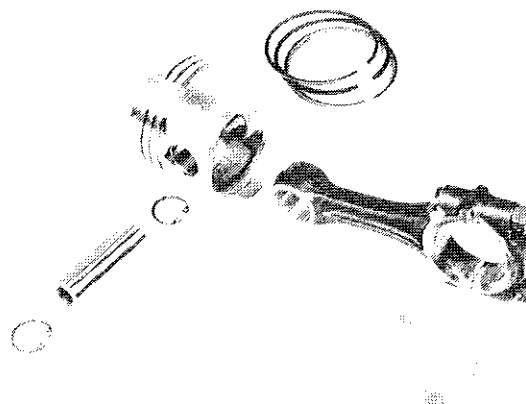

PB040

#### - Inspection

- A. Piston
  - a. If outer surface of the piston is excessively damaged (cracked score, burning, etc.), replace.

#### b. Piston skirt

Check the larger diameter of the piston skirt (10mm from bottom), and check inside diameter (thrust direction) of the cylinder. Calculate the clearance between the cylinder and piston. If this clearance is more than allowable, or piston diameter is less than allowable limit, replace the piston.

103-09 Piston/Perama M25

Standard clearance	Allowable limit
0.0525-0.0825mm (.0021-.0033")	0.25mm (.0098")

Standard diameter	Allowable limit
71.9225-71.9375mm (2.8316-2.8322")	71.7mm (2.8228")

c. Oversized piston

When the cylinder is oversized, ensure that oversized piston is used.

Piston size	Part number	Larger diameter of piston skirt
Standard	115317560	71.9225-71.9375mm (2.8316-2.8322")
0.5mm oversize	115317564	72.4225-72.4375mm (2.8513-2.8519")
1.0mm oversize	115317567	72.9225-72.9375mm (2.8710-2.8716")

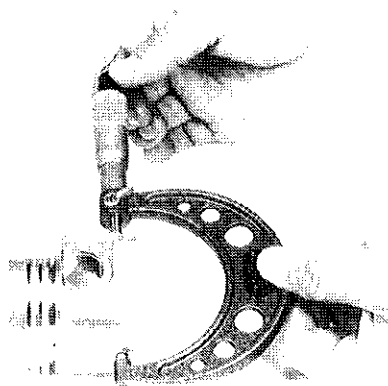

PB041

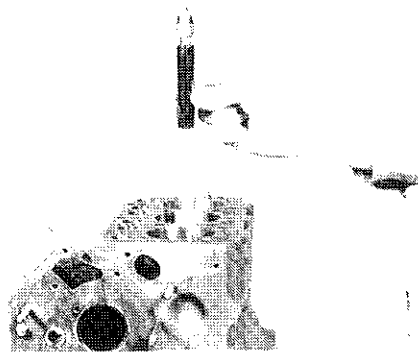

PB042

103-10 Piston/Perama M30

Standard clearance	Allowable limit
0.0425-0.0665mm (.0017-.0026")	0.25mm (.0098")

Standard diameter	Allowable limit
74.9425-74.9575mm (2.950-2.951")	74.7mm (2.9409")

Piston size	Part number	Larger diameter of piston skirt
Standard	115317382	74.9425-74.9575mm (2.950-2.951")
0.5mm oversize	115317386	75.4425-75.4575mm (2.970-2.9706")
1.0mm oversize	115317389	75.9425-75.9575mm (2.9898-2.9904")

102-04, 103-06, M20 Piston

Standard clearance	Allowable limit
0.038-0.072mm (.0015-.0028")	0.25mm (.010")

Standard diameter (Piston)	Allowable limit
63.948-63.963mm (2.5176-2.5182")	63.7mm (2.5079")

Piston size	Larger diameter of piston skirt	Part number
Standard	63.948-63.963mm (2.5176-2.5182")	115317480
0.5mm oversize	64.448-64.463mm (2.5373-2.5379")	115317484
1.0mm oversize	64.948-64.963mm (2.5570-2.5576")	115317487

102-05, 103-07 Piston

STD. clearance	Allowable limit
0.048-0.082 (.0019-.0032)	0.25mm (0.10")

STD. diameter	Allowable limit
66.9375-66.9525 (2.6353-2.6359")	66.7mm (2.6260")

Piston size	Part number	Larger diameter of piston skirt
STD	115317650	66.9375-66.9525 (2.6353-2.6359")
0.5mm oversize	115317660	67.4375-67.4525 (2.6550-2.6556")

d. Clearance between gudgeon pin hole and gudgeon pin.

Check the inside diameter of the gudgeon pin hole and the outside diameter of the gudgeon pin, and calculate the clearance between them.

If the clearance is more than allowable limit, replace.

Standard clearance	Allowable limit
-0.004-+0.004mm (.00015±.00015")	0.02mm (.00078")

B. Piston ring

a. If the piston ring is worn or damaged, replace it.

b. Piston ring gap

Insert the rings into the cylinder at right angle to the cylinder bore and measure the gaps with a thickness gauge. If the gap is more than the allowable limit, replace.

103-09/10/Perama M25/M30

	Standard gap	Allowable limit
No. 1 ring	0.15-0.27mm (.0059-.0106")	1.0mm (.039")
No. 2 ring	0.12-0.24mm (.0047-.009")	1.0mm (.039")
Oil ring	0.2-0.35mm (.0078-.0137")	1.0mm (.039")

102-04, 102-05, 103-06, M20, 103-07 GAP

	Standard gap	Allowable limit
No. 1 ring	0.13-0.25mm (.005-.010")	1.0mm (.039")
No. 2 ring	0.10-.22mm (.004-.009")	1.0mm (.039")
Oil ring	0.10-0.30mm (.004-.012")	1.0mm (.039")

c. Measure the clearance between the piston ring groove and ring. If the clearance exceeds the allowable limit, replace the ring.

	Standard clearance	Allowable limit
No. 1 ring	0.06-0.1mm (.002-.0039")	0.25mm (.0098")
No. 2 ring	0.05-0.09mm (.0019-.0035")	0.25mm (.0098")
Oil ring	0.02-0.06mm (.0007-.002")	0.15mm (.0059")

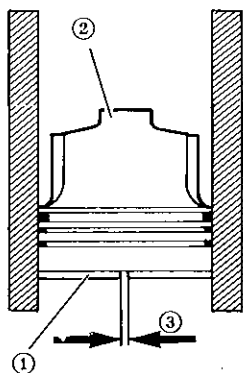

- ① Piston ring
- ② Piston
- ③ End gap

d. Oversize piston ring 103-06

If the cylinder is oversized, oversize piston ring set should be employed.

ENG. TYPE	102-04, 103-06, M20	102-05, 103-07
Piston ring size	Partcode number	Part number
S.T.D	115107260	115107400
O.S. 0.5mm (0.02")	115107263	115107410
O.S. 1.0mm (0.4")	115107265	-

e. Oversize piston ring – 103-09/Perama M25

If the cylinder is oversized, oversize piston ring set should be used.

Piston ring size	Part No.
Standard	115107191
0.5mm oversize (.019")	115107194
1.0mm oversize (0.39")	115107196

f. Oversize piston ring – 103-10/Perama M30

If the cylinder is oversized, oversize piston ring set should be used.

Piston ring size	Part No.
Standard	115107201
0.5mm oversize (.019")	115107204
1.0mm oversize (.039")	115107206

g. Mounting position of the piston ring

Confirm that the piston ring is set as shown in the illustration 1077.

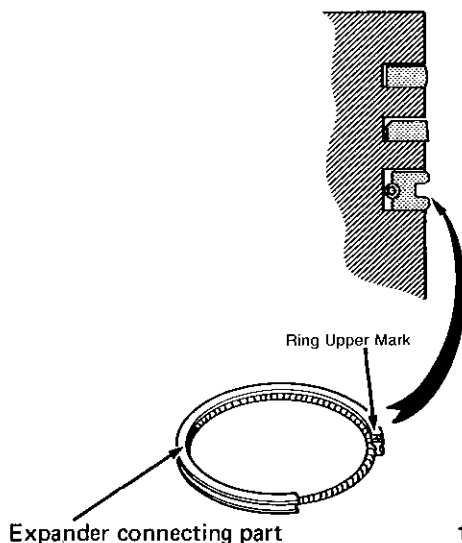



C. Gudgeon pin

Check the outside diameter of the gudgeon pin. If it is less than the allowable limit, replace.

103-09/10/Perama M25/M30

Standard OD	Allowable limit
20.998-21.002mm (.8266-.8268")	20.98mm (.8259")

102-04, 102-05, M20,  
103-06, 103-07 Gudgeon pin

Standard OD	Allowable limit
18.998-19.002mm (.7480-.7481")	18.98mm (.7472")

**Connecting Rod**

**- Inspection**

A. Distortion or damage.

Check the connecting rod for distortion between the large and small ends of the connecting rod with a connecting rod aligner. If the result exceeds the allowable limit, replace.

	Standard value	Allowable limit
Distortion (for 100mm) (3.937")	Less than 0.08mm (.003")	0.2mm (.0078")
Parallel (for 100mm) (3.937")	Less than 0.05mm (.0019")	0.15mm (.0059")

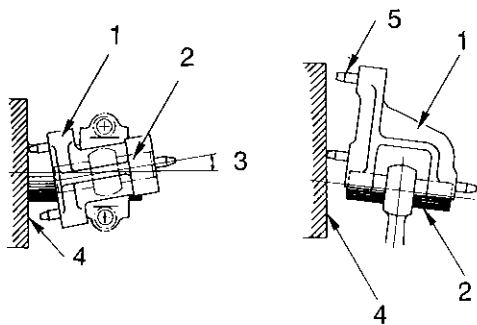

- 1. Gauge
- 2. Gudgeon pin
- 3. Distortion
- 4. Flat surface of the aligner
- 5. Pin

1078

B. Clearance between small end bush and the gudgeon pin.

Measure the inside diameter of the connecting rod small end bush.

If the clearance exceeds the allowable limit, replace.

103-09/10/Perama M25/M30

Standard clearance	Allowable limit
0.008-0.023mm (.0003-.0009")	0.08mm (.003")

102-04, 103-06, M20, 103-07 Clearance

Standard clearance	Allowable limit
0.013-0.028mm (.0005-.0011")	0.08mm (.0031")

C. Play between the connecting rod and the crankshaft.

Assemble the connecting rod to the crankshaft, and measure the play in shaft direction. If the play is more than the allowable limit, replace the connecting rod.

Standard play	Allowable limit
0.1-0.3mm (.0039-.0118")	0.7mm (.0275")

D. Oil clearance

Using the plastiguage, check the oil clearance as follows.

Remove oil or foreign matter from the bearing and crankshaft.

Cut the plastiguage to the same width as the bearing. Place it on the crankshaft. Avoid the oil hole.

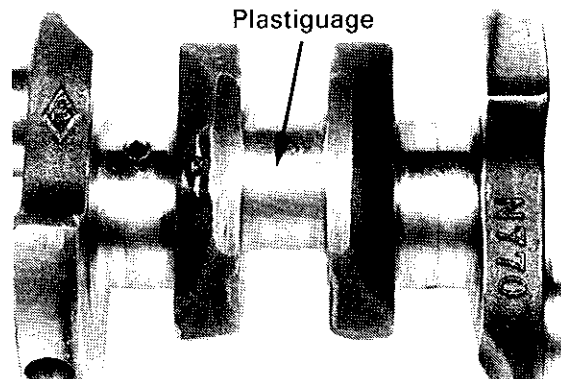

Assemble the connecting rod and connecting rod cap, and tighten to the specified torque (3.0-3.5kgf.m) (21.7-25.3lbf.ft) – 103-09/10/Perama M25/M30, (2.1-2.6kgf.m) (15.2-18.8lbf.ft) – 103-06/07, M20, 102-04/05

NOTE: Never rotate the connecting rod.

Remove the connecting rod cap. Measure the oil clearance with the scale printed on the gauge bag.

NOTE: Measure the widest area.

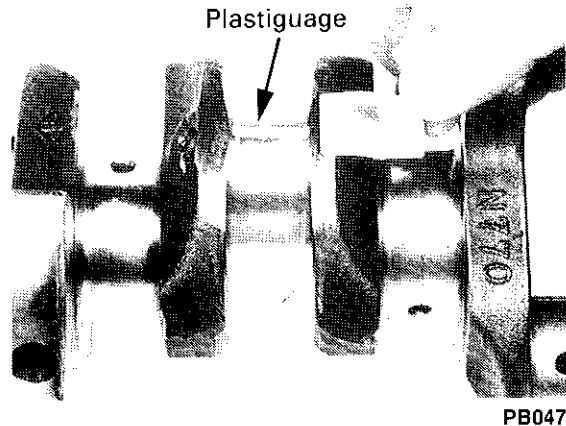

103-09/10/Perama M25/M30

Standard clearance	Allowable limit
0.035-0.083mm (.001-.003")	0.2mm (.0078")

102-04, 102-05, 103-06, M20, 103-07

Standard clearance	Allowable limit
0.031-0.079mm (.0012-.0031")	0.2mm (.0078")

If the oil clearance exceeds the allowable limit, replace the bearing. Or, grind the crankshaft and use oversize bearing.

NOTE: When grinding the outside diameter of the crankshaft, ensure that the oil clearance is correct before reassembly.

103-09/10/Perama M25/M30

Bearing size	Part number	Crankshaft pin O.D. dimension (mm)
Standard	198517130	38.964-38.975mm (1.5340-1.5344")
0.25mm U.S. (.0098")	198517134	38.714-38.725mm (1.5241-1.5246")
0.50mm U.S. (.0196")	198517137	38.464-38.475mm (1.5143-1.5147")

102-04/05, 103-06/07, M20

Bearing size	Crankshaft pin O.D. dimension (mm)	Part No.
S.T.D.	34.964-34.975mm (1.3765-1.3770")	198517310
0.25mm U.S. (.010")	34.714-34.725mm (1.3667-1.3671")	198517314
0.50mm U.S. (.020")	34.464-34.475mm (1.3568-1.3573")	198517317

#### - Reassembly

- Reassemble the piston on the connecting rod as follows.
- With a piston heater or the like, heat the piston to approximately 100°C. Then, assemble the piston to the connecting rod by aligning the set marks.
- Set the 'SHIBAURA' marks or 'F' mark as shown in the illustration PB048. Align the set marks (figures) at (A) on the connecting rod.

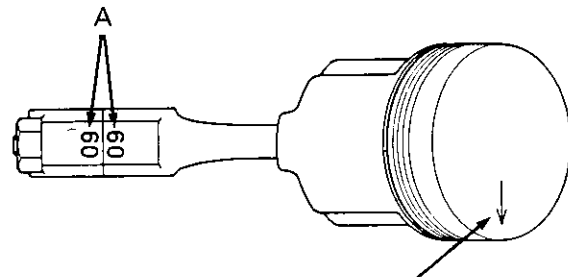

Arrow mark or 'F' (102-04/05),  
(103-06/07), M20

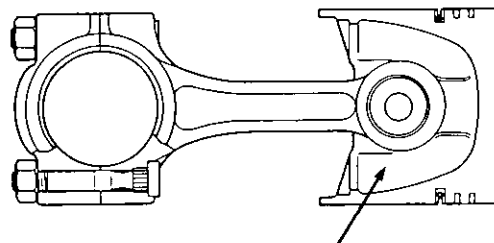

Shibaaura mark (103-09/10)  
(M25/M30) PB048

- Replace the piston ring on the piston. Position scribe mark uppermost.
- When the connecting rod or piston/gudgeon pin has been replaced, difference in weight of the assembly (connecting rod plus piston rings) should not exceed 10 grams between cylinders.

## Bearing Holder

### - Disassembly and Inspection

#### A. Centre bearing

- Remove the bearing holder, and check it for peeling, melting, stepped wear and other damage. If it is excessively damaged, replace.
- Using the plastigauge, measure the oil clearance between the crankshaft centre journal and the bearing.

If the oil clearance is more than the allowable limit, replace the bearing. Or, grind the crankshaft centre journal, and use under-sized bearing (Refer to "Crankshaft").

103-09/10:Perama M25/M30

Standard oil clearance	Allowable limit
0.039-0.092mm (.0015-.0036")	0.2mm (.0078")

Bearing size	Bearing Number	Crankshaft centre journal diameter (mm)
Standard	198517101* 198517110	45.964-45.975mm (1.8096-1.8100")
0.25mm U.S. (.0098")	198517105* 198517114	45.714-45.725mm (1.7997-1.8001")
0.50mm U.S. (.0196")	198517108* 198517117	45.464-45.475mm (1.7899-1.7903")

\* Upper bearing

#### Bearing Holder

Journal No.	Standard oil clearance	Allowable limit
103-06/07, 102-04/05 M20		
No. 1, 2	No. 1	0.035-0.088 (.0014-.0035")
No.3	No.2	0.039-0.092 (.0015-.0036")

102-04/05

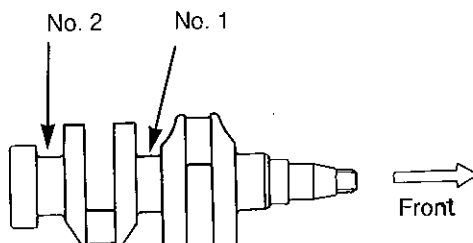

Bearing size	Journal No.	Part No.	Crankshaft center journal diameter
	103-06/102-04/103-07/102-05/		
	M20		
S.T.D	No.1	No.1	198517330* 42.964-42.975
	No.2		198517340 (1.6915-1.6919")
	No.3	No.2	198517101* 45.964-45.975"
			198517110 (1.8096-1.8100")
U.S. 0.25 (.010")	No.1	No.1	198517334* 42.714-42.725
	No.2		198517344 (1.6817-1.6821")
	No.3	No.2	198517105* 45.714-45.725
			198517114 (1.7998-1.8002")
U.S. 0.50 (.020")	No.1	No.1	198517337* 42.464-42.475
	No.2		198517347 (1.6718-1.6722")
	No.3	No.2	198517108* 45.464-45.475
			198517117 (1.7899-1.7904")

\*Upper bearing

103-06/07/09/10, Perama M20/M25/M30

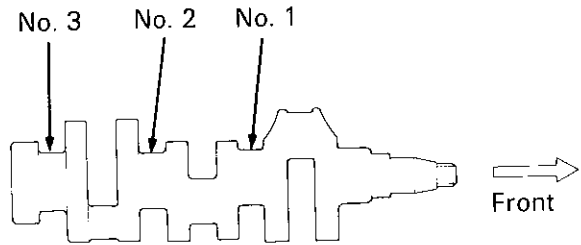

PB049

#### B. Thrust clearance 102-04/05, 103-06/07, M20

Check the thrust clearance for wear, poor contact, burning or other defects.

N.B. No thrust washers are fitted.

Standard clearance	Allowable limit
0.1 to 0.3mm (.004-.012")	0.5mm (.020")

Thrust washers only used with cast iron No.3 bearing holder. (No.3 bearing holder also made of aluminium die casting). 103-09/10, Perama M25/M30.)

Check the thrust washers or No.3 bearing holder for wear, poor contact, burning or other defects. Defective washers or bearing holder must be replaced.

#### Thrust Washer

Standard Thickness	Allowable Limit
1.95 - 2.0mm	1.8mm

#### Bearing Holder

Standard Thickness	Allowable Limit
21.85 - 21.95mm	21.6mm

**- Reassembly**

- A. Reassemble the bearing holder, centre bearing and thrust washer as follows:
- Face the chamfered part of the bearing holder toward front. Install the bearing holder which has reference bit at the centre. Then install the bearing holder on which the thrust washer is to be mounted at the flywheel side (where fitted).
  - Install the thrust washer when using cast iron bearing holder on model 103-09/10/Perama M25/M30. Face its oil groove toward thrust face of the crank-shaft.  
Tightening torque of the cast iron bearing holder: (2.5-3.0kg f.m) (18.1-21.7lbs-ft) and for aluminium die cast bearing holder only: (2.0-2.5kg f.m) (14.5-18.1 lbs-ft) - 102-04/05, 103-06/07/09/10 and Perama M20/M25/M30.
  - Set the bearing with oil groove to upper part, while setting the bearing without the groove to lower part.

103-09/10/Perama M25/M30

Standard oil clearance	Allowable limit
0.039-0.106mm (.0015-.0041")	0.2mm (.0078")
102-04, 103-06/07, M20 0.035-0.102mm (.0014-.0040")	0.2mm (.0078")

103-06/07/09/10, Perama M20/M25/M30

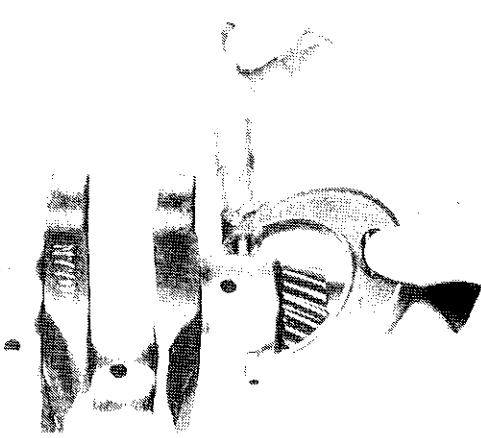
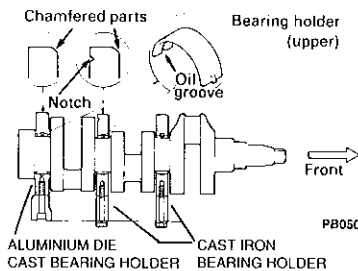

PB052

102-04/05

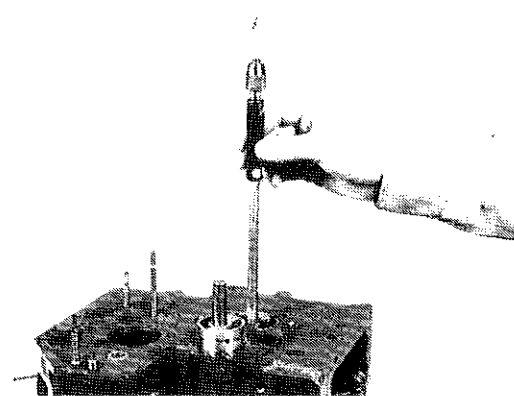
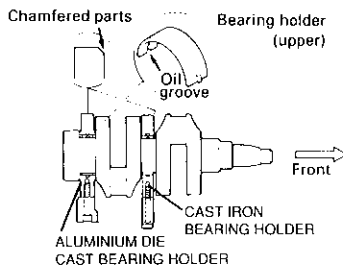

PB053

**Crankshaft Bearing (bush)**

**- Inspection**

- Check the bearing (bush) for peeling, melting, seizure or poor contact. If found to be defective, replace.
- Using cylinder gauge and micrometer, measure the oil clearance between the bearing (bush) and the crankshaft journal.
- Measure inside diameters at positions 1 and 2 (1085). At each position, measure in both directions A and B as shown. The oil clearance can be obtained by subtracting this value from the maximum crankshaft journal diameter.

- If the oil clearance exceeds the allowable limit, replace the bearing (bush). Or, grind the crankshaft journal. In this case, use undersize bearing (bush).
- When replacing the crankshaft journal (bush), use a press to install.

Crankshaft journal (bush)

103-09/10/Perama M25/M30

Size	Cord number	Outside diameter
Standard	198517080	45.964-45.975mm (1.8096-1.8100")
0.25mm U.S. (.0098")	198517084	45.714-45.725mm (1.7997-1.8001")
0.50mm U.S. (.0196")	198517087	45.464-45.475mm (1.7899-1.7903")

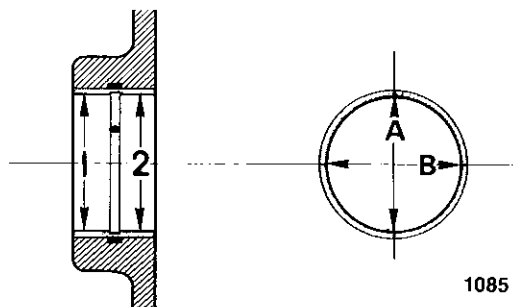

1085

F. After grinding the crankshaft journal, check the oil clearance.

Crankshaft journal (bush) 102-04/05, 103-06/07, M20

Bush size	Bush code No.	Crankshaft journal O.D. finished size (ø)
S.T.D.	198517300	42.964-42.975mm (1.6915-1.6919")
U.S.O. 25 (.010")	198517304	42.714-42.725mm (1.6817-1.6821")
U.S.O. 50 (.020")	198517307	42.464-42.475mm (1.6718-1.6722")

After grinding the crankshaft journal, confirm that correct oil clearance.

**How To Replace Bush**

**1. Removal of bush**

Remove the bush from the housing (Cylinder Block) using Bush Driving Tool to prevent damage.

**2. Press fitting the bush**

2.1 Prior to installing the bush inspect the bush housing for marks, scratches, etc.

2.2 The bush should be smoothly pressed in to correct depth by using Bush Driving Tool, adjusting the oil hole and direction of bush as per attached PB129 and following sequence.

(1) Press in the bush to cylinder block from engine front side.

**Note:**

Must not press in the bush to cylinder block from the opposite side.

The correct pressing side is chamfered etc, to allow smooth operation.

(2) Align oil hole of the housing and bush.

(3) install the bush confirming the mark and oil groove (hole).

(4) Lubricate at outer surface of the bush.

(5) Press in the bushing to the housing until correct depth by using Bush Driving Tool.

**2.3 Confirm after installation**

Confirm the alignment of oil hole of the housing and the bush, also check inner diameter is within tolerance.

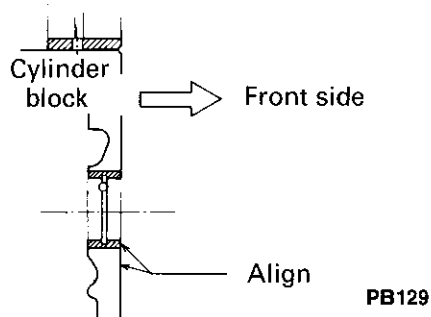
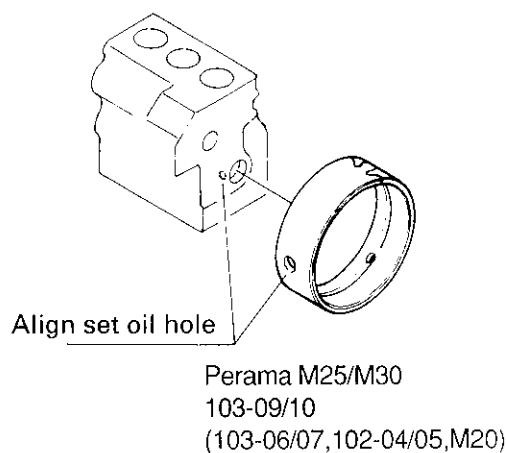

**Crankshaft**

**- Inspection**

**A. Crankshaft deflection**

Support the crankshaft with V-block. Position a dial gauge on the crankshaft centre journal, and turn the crankshaft gradually by one full turn. If the gauge reading is more than allowable limit, correction or replacement of the crankshaft is needed.

Standard deflection	Allowable limit
0.03mm or less (.0011")	0.06mm (.0023")

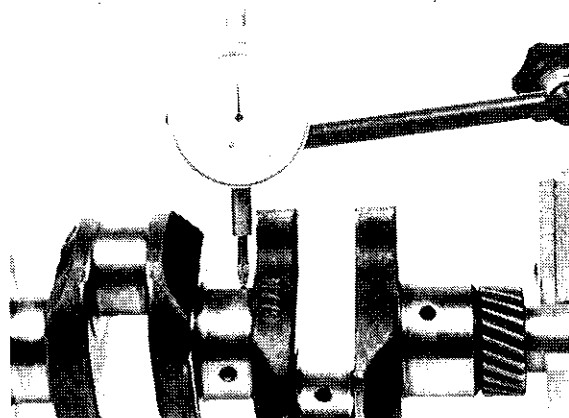

- B. Oil Seal contact face and oil hole  
Check the oil seal contact face for damage or wear.  
Check oil holes for clogging.

- C. Crankshaft journal and pin for stepped wear.  
Take four measurements (AA and BB diameters at positions "1" and "2"). If the maximum difference between the measurements is more than allowable limit, correction is required.

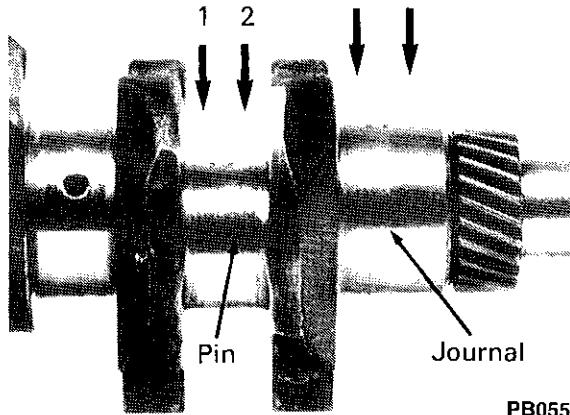

PB055

Cross Section of Pin and Journal

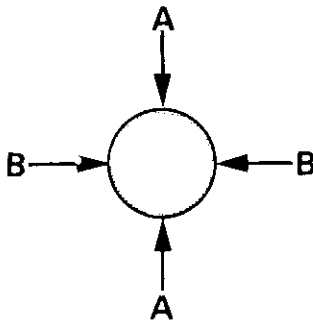

Allowable difference (stepped wear)

0.05mm (.0019")

When measured diameter is less than the allowable limit, correct by grinding and use undersize bearings and bush.

103-09/10/Perama M25/M30  
Shaft diameter of crankshaft journal

	Standard diameter	Allowable limit
Standard	45.964-45.975mm (1.8096-1.8100")	45.9mm (1.807")
0.25mm U.S.	45.714-45.725mm (1.7997-1.8001")	45.65mm (1.797")
0.50mm U.S.	45.464-45.475mm (1.7899-1.7903")	45.40mm* (1.787")

103-09/10/Perama M25/M30  
Shaft diameter of crankshaft pin

	Standard diameter	Allowable limit
Standard	38.964-38.975mm (1.5340-1.5344")	38.90mm (1.531")
0.25mm U.S.	38.714-38.725mm (1.5241-1.5246")	38.65mm (1.5216")
0.50mm U.S.	38.464-38.475mm (1.5143-1.5147")	38.40mm* (1.5118")

\* If the diameter is less than this value, the crankshaft must be replaced with new.

Crankshaft journal shaft diam. ø

	Assy'd std. value			Repair req value
	103-06/07/M20	102-04/05		
Standard	No.1	No.1	42.964-42.975 (1.6915-1.6919")	42.90 (1.689")
	No.2	No.1		
	No.3	No.2	45.948-45.959 (1.8090-1.8094")	45.90 (1.807")
U.S. 0.25 (.01")	No.1	No.1	42.714-42.725 (1.6817-1.6821")	42.65 (1.679")
	No.2	No.1		
	No.3	No.2	45.698-45.709 (1.7991-1.7996")	45.65 (1.797")
U.S. 0.50 (0.02")	No.1	No.1	42.464-42.475 (1.6718-1.6722")	42.40* (1.669")
	No.2	No.1		
	No.3	No.2	45.448-45.459 (1.7893-1.7897")	45.40* (1.787")

Crankshaft pin diameter (ø) 102-04/05, 103-06/07, M20

	O.D. finished size	Repair req. value
Standard	34.964-34.975 (1.3765-1.3770")	34.90 (1.374")
U.S. 0.25 (.01")	34.714-34.725 (1.3667-1.3671")	34.65 (1.364")
U.S. 0.50 (.02")	34.464-34.475 (1.3568-1.3573")	34.40* (1.354")

\* Replace crankshaft if U.S. 0.50 is exceeded.

NOTE: When grinding the crankshaft, work with the following specifications:

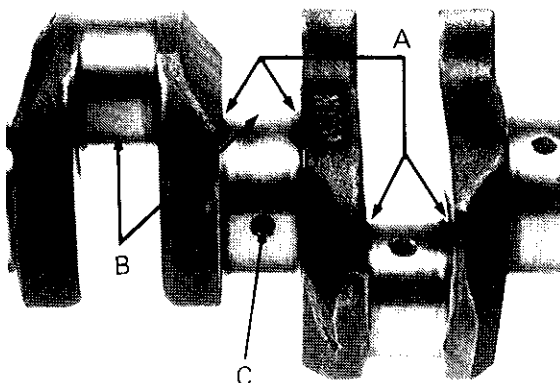

PB057

- (A): Radius at pin/journal  
3mm ± 0.2mm  
.118 .0078
- (B): Finish precision  
1.6Z (▽▽▽)
- (C): Radius around oil hole:  
.0787"/2mm in maximum  
.196"/5mm in minimum

Use No. 400 emery cloth for final polishing.

103-09/10/Perama M25/M30  
(A) Cam height (intake and exhaust cams)

Standard value	Allowable limit
26.445-26.5mm (1.041-1.043")	26.1mm (1.0275")

102-04/05, 103-06/07, M20

Standard value	Allowable limit
26.565-26.62mm (1.0459-1.0480")	26.1mm (1.0275")

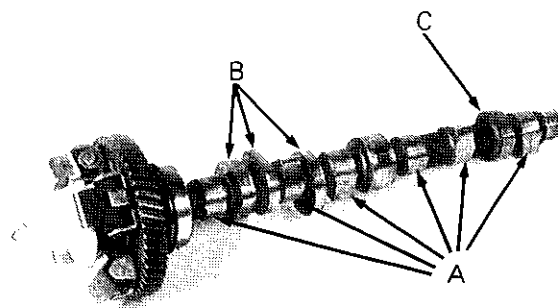

PB059

103-09/10/Perama M25/M30  
(B) Height of cam for injection pump

Standard height	Allowable limit
33.94-34.06mm (1.336")	33.8mm (1.341")

102-04/05, 103-06/07, M20

Standard height	Allowable limit
34.48-34.52mm (1.3575-1.3591")	34.3mm (1.3504")

(C) Height of cam for fuel feed pump  
- All engines

Standard height	Allowable limit
27.9-28.0mm (1.098-1.102")	27.0mm (1.06")

**Flywheel and Ring gear**

**- Inspection**

- A. Check the ring gear. If it is excessively damaged or worn, replace it.
- B. When wear is not excessive, remove the ring gear and reinstall 90° from original position. To install, preheat the ring gear up to 120° to 150°C.

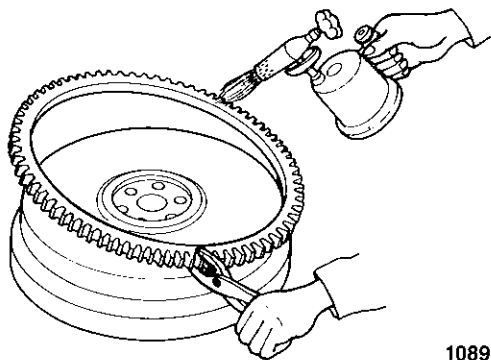

1089

**Camshaft Assembly**

**- Inspection**

- A. Check the journals and cams for wear and damage. Replace if the allowable limit is exceeded.
- B. Correct uneven wear or small scratches on the cam surface with oil stone.

C. Camshaft gear and bearing assembly:

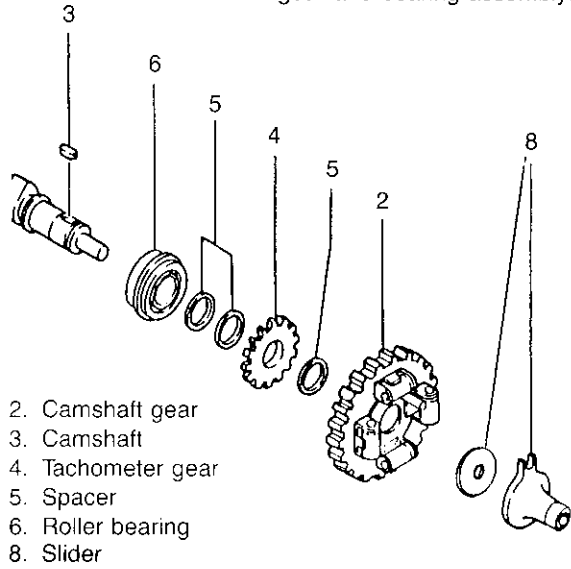

- 2. Camshaft gear
- 3. Camshaft
- 4. Tachometer gear
- 5. Spacer
- 6. Roller bearing
- 8. Slider

1090

If these items have been replaced it is essential the spacers and shims etc are assembled in the order illustrated in 1090.

**Timing Gear**

**- Inspection**

- A. Check the timing gears for wear and damage on the contact area. Replace if any defect is found.
- B. Measure the back-lash of gears with a thickness gauge or dial gauge. If the allowable limit is exceeded, replace all timing gears.

Standard back-lash	Allowable limit
0.08mm (.003")	0.25mm (.010")

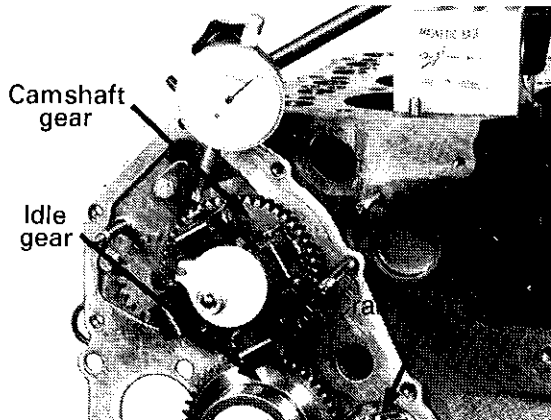

PB060

**Oil Pump**

**- Disassembly**

- A. Remove the snap ring.
- B. Take out collar spring and shim.
- C. Remove idle gear vane and oil pump cover together.
- D. Pull out rotor and thrust washer.
- E. Pull out the oil pump cover from idle gear.
- F. Remove spring from the idle gear.

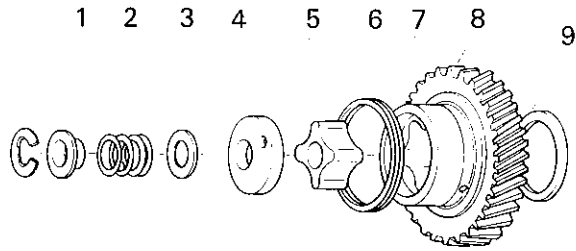

PB061

- 1. Snap ring
- 2. Collar
- 3. Spring
- 4. Shim
- 5. Oil pump cover
- 6. Rotor
- 7. Spring
- 8. Idle gear
- 9. Thrust washer

**- Inspection**

- A. Check oil pump cover, rotor and vane for wear. If excessively worn or damaged; replace.
- B. Check the clearance between the rotor and vane.  
If the clearance is excessive, replace.
- C. If the idler gear hub needs replacing contact Perkins service department for procedure.

**- Reassembly**

- A. Reassemble the oil pump in reverse order of disassembly.
- B. Align set marks on the crankshaft gear and idle gear to reassemble.
- C. Check the side clearance between the rotor and vane is 0.01 to 0.15mm (.0004 to .006"). Allowable limit 0.25mm (.0098").

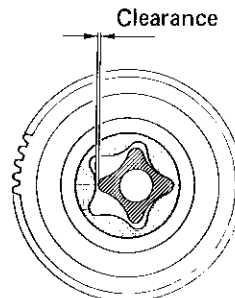

1094



## Oil Filter

### - Construction and Function

This engine employs a cartridge type filter.

Pressurized oil from the oil pump enters from (A); and is filtered by a full flow filter, before discharge through (B).

When the full flow filter is clogged, the safety valve opens to bypass the oil.

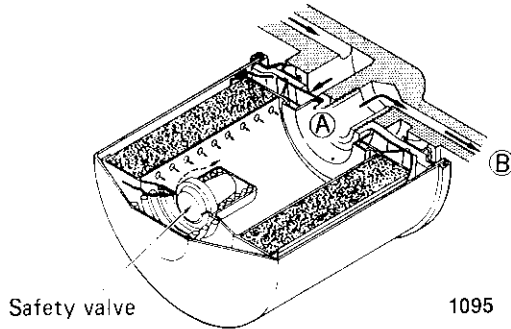

### - Maintenance

- A. The oil filter must be replaced every 100 hours of operation.

When installing a new filter, coat its mounting face with clean oil then hand tighten only.

## Water Pump Assembly and Thermostat housing

### - Disassembly

- A. Remove the set plate and gasket.
- B. Take out the thermostat and spring from the thermostat housing (on the 102-04/05, 103-06/07, M20) and from the water pump body on the 103-09/10 and Perama M25/M30.

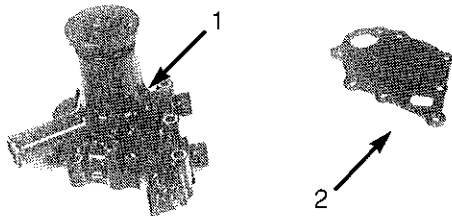

103-09/10, M25, M30

PB064

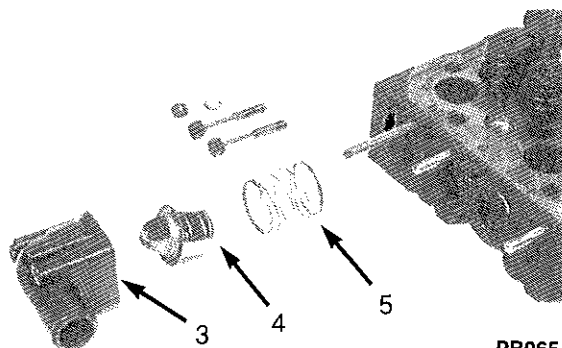

102-04/05, 103-06/07, M20

PB065

- 1. Water pump
- 2. Set plate
- 3. Thermostat housing
- 4. Thermostat
- 5. Spring

## - Inspection

### Thermostat

- A. Replace the thermostat if the valve opens at ambient temperature.
- B. Place the thermostat into water. Raise the water temperature gradually and inspect the valve opening temperature and valve lift. (Standard values are as described in the "Specifications".)

NOTE: 3 to 5 minutes will be required before the valve starts operating.

Type	103-09/10/Perama M25/M30 Wax pellet type	102-04/05, 103-06/07, M20 Wax pellet type
Temperature when starting to open	80 to 84°	73 to 77°
Temperature when fully open	95°	87°
Valve lift (when the water temperature is 82°C)	8.0mm	6mm

EARLIER ENGINES HAD LOWER TEMPERATURE SETTINGS

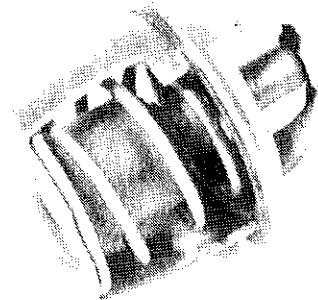

PB066

### Water Pump

- A. Check for cracks, wear, leaks, bearing roughness or damage. If defective replace assembly.

### - Reassembly

- A. Assemble the thermostat and spring in the water pump casing or housing, as appropriate. Install the gasket and set plate.
- B. Rotate the fan holder to confirm that there is no fouling.

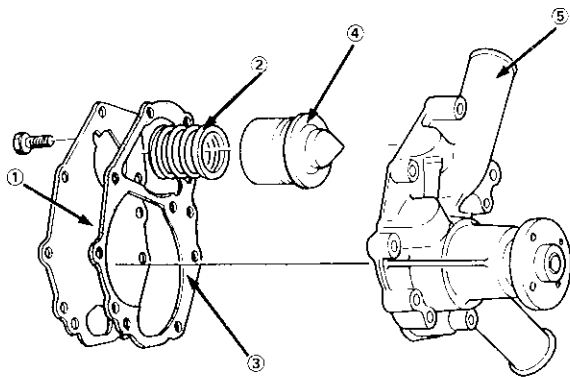

- 1. Set plate
- 2. Spring
- 3. Gasket
- 4. Thermostat
- 5. Pump case

E0072

**Radiator 102-04/05, 103-06/103-07/09/10**

A pressure type radiator cap is employed to obtain higher cooling efficiency. When the coolant pressure builds up to the range of  $0.9 \pm 0.15 \text{ kg/cm}^2$  (6.5lb/ft to 10.8lb/ft) excessive pressure is relieved from the overflow pipe. (shown by white arrow).

When coolant temperature falls coolant pressure may become less than atmospheric pressure. As this may fracture the radiator, the vacuum relief valve opens at  $0.04$  to  $0.05 \text{ kg/cm}^2$  (2.9lb/ft to 3.6lb/ft) to protect the radiator. (black arrow).

N.B. Perama M20/M25/M30 pressure cap is  $0.5 \text{ kg/cm}^2$

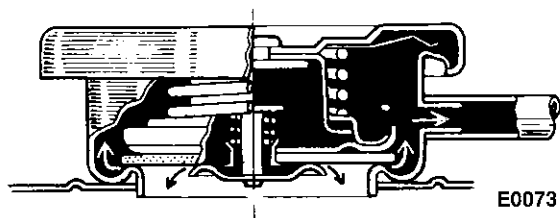

E0073

**– Inspection**

- A. Check the radiator for water leaks. If water leaks, repair or replace the radiator.
- B. Check radiator fins for clogging by mud and/or other foreign matter. If clogged, clean the fins.
- C. Check the pressure cap and vacuum pressure relief cap for operating pressure or contacting condition. If found to be defective, replace.
- D. Check the radiator hoses. If damaged or perished replace.

**Fuel Filter**

The fuel line is shown in the illustration.

The fuel which lubricated the injection nozzle needle is returned to the tank through the overflow pipe.

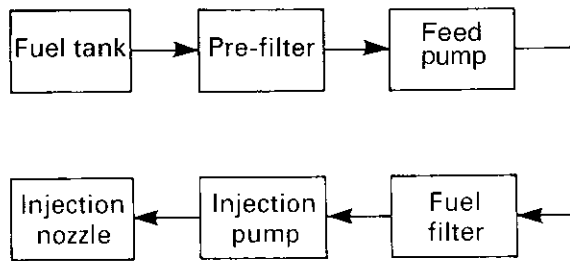

PB068

**– Inspection**

- A. Check inside the fuel filter. If water or foreign matter is found, remove it. If needed, replace the fuel filter.

**– Disassembly/Reassembly**

- A. Turn the filter ring nut counterclockwise to remove it. (for 102-04/05, 103-06/07, M20).

NOTE: An O-ring is inserted between the ring nut and filter body. This ring should be coated with grease to aid assembly.

- B. Coat the mounting face of the element with grease, and install it hand tight. (All types).

**Feed Pump Assembly**

**– Disassembly**

- A. Before disassembly see section A, B, C of Inspection and then note reference marks on the diaphragm cap, top body assembly and bottom body as shown in the figure.

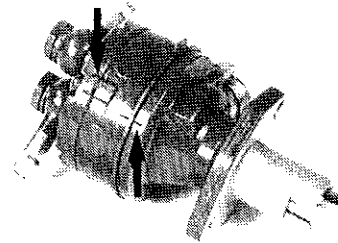

PB069

- B. Remove the bolt to remove the cap and top body assembly.

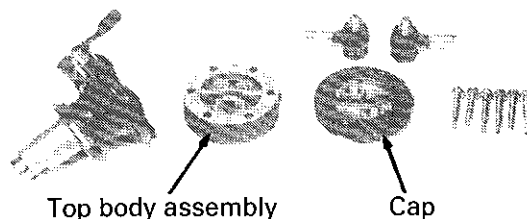

Top body assembly

Cap

PB070

- C. Remove the diaphragm from the bottom body, and turn the piston to align the bottom body groove with the pin hole.
  - D. Remove the pin from the piston.
- NOTE: Pay attention to the inner spring.

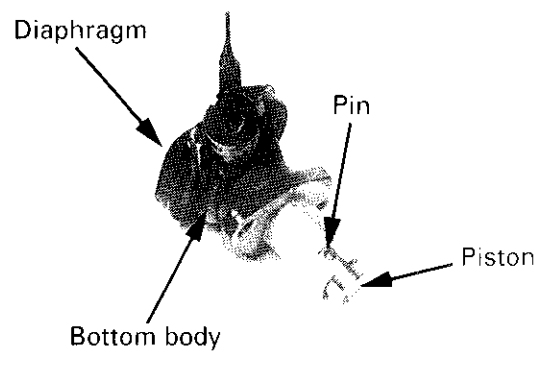

PB071

- B. Drain all fuel in the feed pump.
- C. Check condition of the top body as follows. Draw air from IN side with vacuum and put air into OUT side. If air stops in both cases, the body is normal.

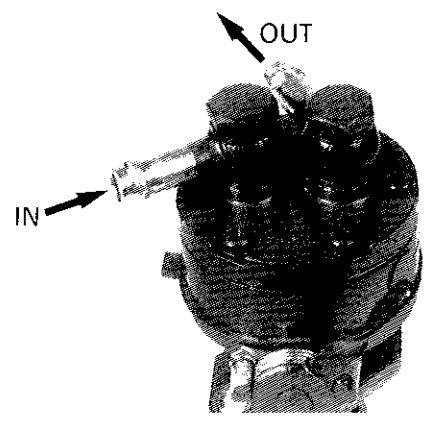

PB074

- E. Take out the piston, spring and diaphragm from the bottom body.

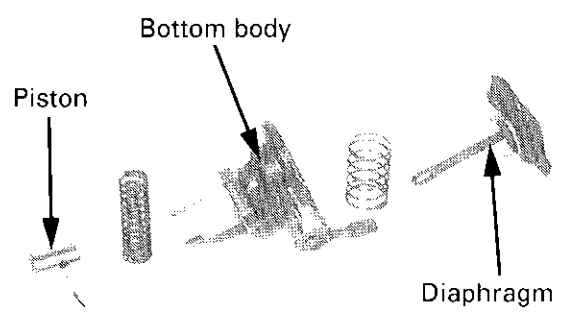

PB072

- D. Confirm that the diaphragm has no damage, such as cracks.

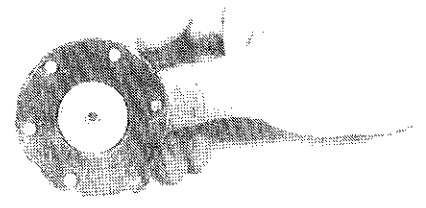

PB075

**- Inspection**

- A. Before disassembling the feed pump, confirm that the piston and bottom body are not seized.

**- Reassembly**

- A. Reassemble the feed pump in the reverse order of its disassembly.

**Governor**

**- Construction/Function**

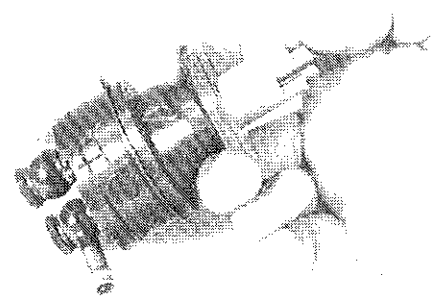

PB073

Link →

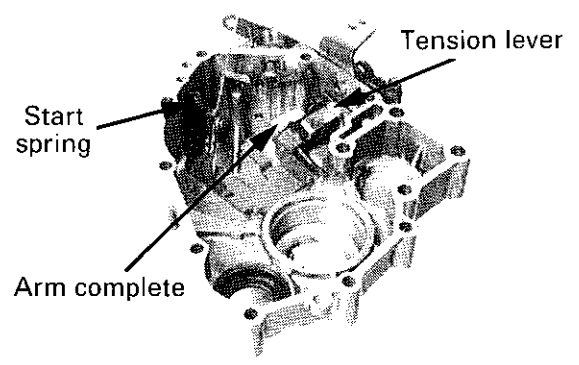

PB076

- A. A mechanical all speed governor is used. It is housed in the gear case.

A flyweight assembly is mounted on the camshaft. The movement of the flyweight is transmitted to the injection pump control rack by way of the slider, control lever and link. A spring which is hooked to the arm and tension lever regulates the movement of the flyweight.

By changing the set angle of the governor lever, tension on this spring is changed. Thus, the engine speed can be regulated by the governor lever.

- B. Maximum speed set bolt.

Set bolt is mounted on the cylinder block. This

bolt limits the movement of the arm and has been adjusted and sealed at the factory.

- C. Max. fuel and start spring.

These are built into the cylinder block, to regulate fuel injection at high speed. Regulation of fuel injection in the middle speed range is by torque spring to realize higher torque.

A start spring is placed between the gear case and link. This spring automatically functions to increase fuel during the start mode.

An idling spring at the gear case stabilizes engine idling speed.

The max. fuel has been adjusted at the factory and sealed.

## Nozzle and Holder

### – Specification

Item	Perama M25/M30/103-09/103-10	103-06/07, Perama M20, 102-04/05
Part code	131406330	131406340
Assembly number	093500-3320	093500-2240
Nozzle holder	093100-3320 (ND-KCA46SD332)	093100-2240
Nozzle	093400-1460 (ND-DN4SDND146)	093400-5010 (ND-4PDI)
Nozzle type	Throttle type	Throttle type
Needle valve diameter	6mm	3.5mm
Pintle diameter	–	1mm
Valve opening pressure	115-125kg/cm <sup>2</sup> (111-121ats)	115-125kg/cm <sup>2</sup>
Spraying angle	4°	4°

### – Construction/Function

- A. The nozzle has been machined to inject fuel, which is pressure-fed from the injection pump to the combustion chamber. Fuel is pressure-fed from the oil hole of the nozzle holder to the nozzle body and sprayed from the nozzle compressing the spring when the pressure exceeds the specified value. Some fuel lubricates and cools the nozzle and nozzle body, and returns via the return pipe.

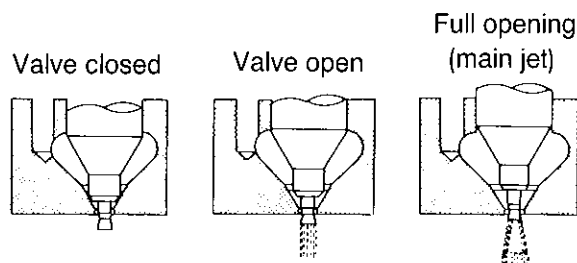

### – Disassembly/Inspection

- A. Place the nozzle holder (body) in a vice and turn the nozzle nut to disassemble.

NOTE: Care should be taken so that the needle valve does not fall when the nozzle is removed.

- B. Wash the nozzle body and needle valve and inspect the nozzle for seizure, sticking and fuel leakage on the seat surface. If fuel leakage is detected, replace the nozzle.
- C. Inspect the upper and lower contact surfaces of the distance piece and correct so that positive contact can be obtained.
- D. Check the nozzle needle valve-contact surface on the push rod for wear, and spring seat for cracks.

### – Reassembly/Adjustment

- A. Before fitting a new nozzle assembly, soak it in heated light oil (50°-60°C) to remove anti-corrosive agent from the nozzle. Then, slide the body on the needle valve so that they slide smoothly.
- B. Turn the nozzle body upside down, fit the shim, spring, rod, piece and nozzle in this order, and tighten with a nozzle nut.

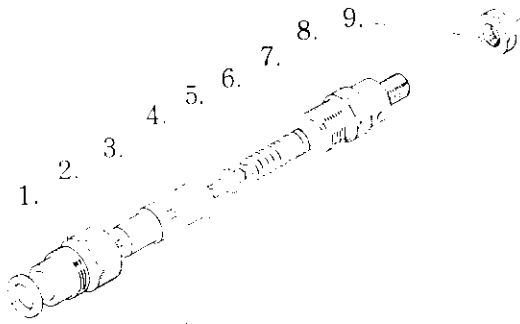

1118

1. Gasket
2. Nozzle nut
3. Nozzle
4. Spacer
5. Rod
6. Spring
7. Shims
8. Body

#### Tightening torque

102-04/05	103-09/10
103-06/07	Perama M25/M30
Perama M20	
3.5~4.0kg f.m	6.0~8.0kg f.m

9. Nut

#### Tightening torque

102-04/05	103-09/10
103-06/07	Perama M25/M30
Perama M20	
2.5~3.0kg f.m	4.0~5.0kgf.m

- C. After reassembly, inspect the injection pressure of the nozzle.

Adjust the pressure with adjusting shims using a nozzle tester so that the injection starts at 120kg/cm<sup>2</sup> 1,707psi 116ats. (The pressure increases or decreases about 10kg/cm<sup>2</sup> 142psi 9.7ats with a shim of 0.1mm thick.)

- D. Spray condition
  - a. Fuel drops should not be mixed in the spray pattern.
  - b. Fuel should be sprayed in conical shape with respect to the nozzle axis.
  - c. Check that the fuel is sprayed in a circular shape when tested.
  - d. Hold the pressure at 100kg/cm<sup>2</sup>, 97ats, lower by 20kg/cm<sup>2</sup>, 20ats, than specified (120kg/cm<sup>2</sup>) and check that no test oil drops from the nozzle tip.

### Air Cleaner

#### – Construction/Function

The cyclonic air cleaner houses a paper element which removes dirt or dust from air drawn in.

#### – Inspection/Replacement

- A. At every 100-200 hours of operation, take out the element and clean it by blowing compressed air (pressure lower than 100psi.)
- B. When oil or soot is stuck to the element, soak it in synthetic detergent for approximately 15 minutes. Then, rinse it in the detergent several times, and wash it in clean water. Finally, leave to dry.
- C. When operating the machine in dusty environment, increase service frequency.
- D. At every sixth cleaning or every year, replace the element.
- E. After cleaning the element, put a light inside the element, and check it for cracks, holes or wear.  
If damage is found or the gasket is broken, replace the element.
- F. Do not install the element until completely dry.

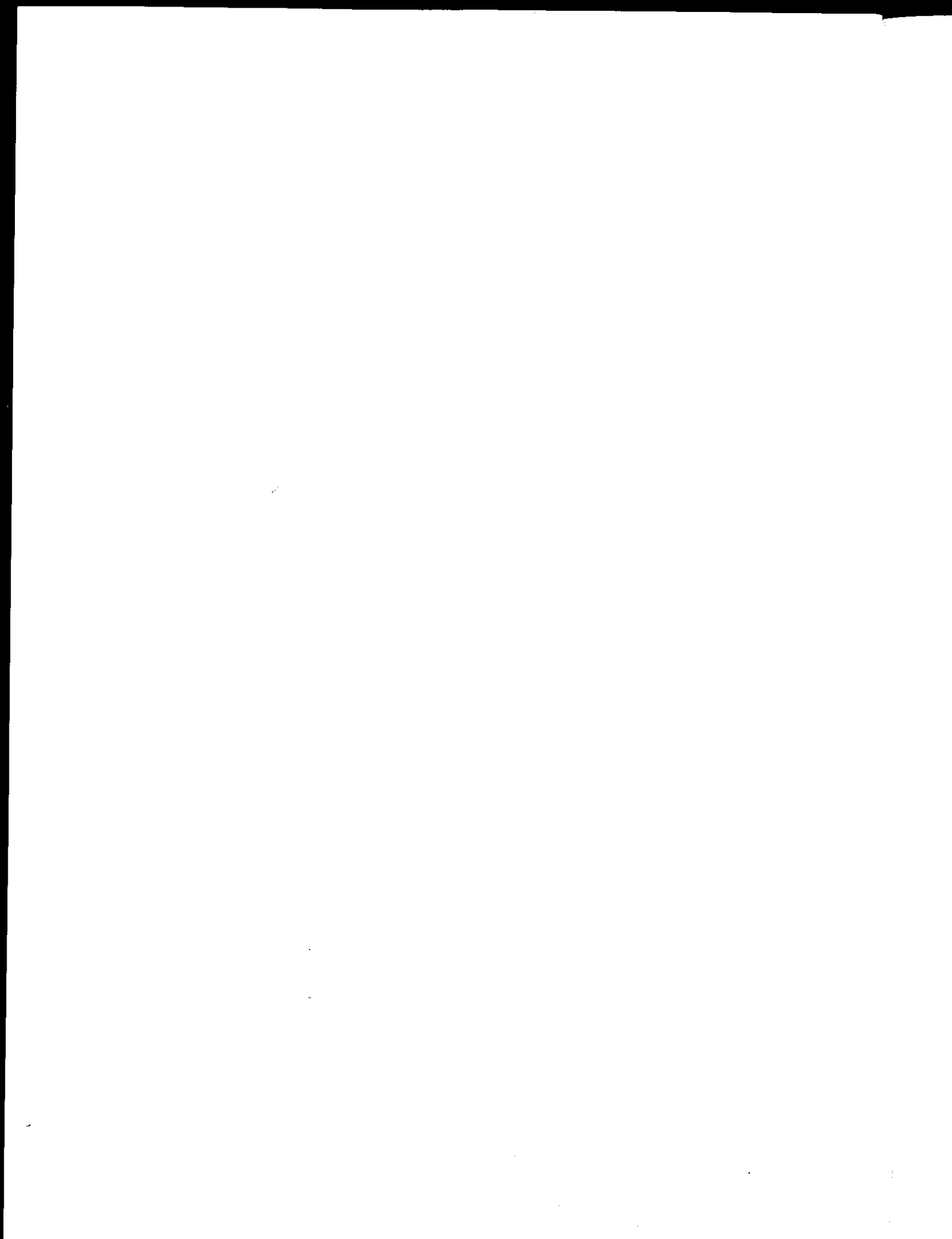

# SECTION V

## Reassembly

### Precautions Before Assembling

- Wash parts before assembling. (Especially, oil gallery, bearings, pistons and cylinder bores should be washed thoroughly.)
- Apply new oil to sliding and rotating surfaces of cylinder bores, pistons and bearings, etc.
- Replace gasket, packing, etc. Use liquid gasket to prevent oil leakage where necessary.
- Never overtighten bolts and nuts used on aluminium alloy: tighten to specified tightening torques.

### Relief Valve Assembly

- Install an O-ring on the relief valve assembly.

Relief valve tightening torque:  
6.0 to 7.0kgf.m (43 to 50lb/ft.)

### Crankshaft and Bearing Holder Assembly

- Install the bearing holders on the crankshaft. Insert this in the bush at the front end of the cylinder block.
- Align the bolt hole at lower part of the cylinder block with thread hole on the bearing holder, and tighten with bolts. For flywheel end, use two special bolts, hex. recess in its head.

Bearing holder tightening torque:  
2.5 to 3.0kgf.m (18 to 22lb/ft) ALL TYPES

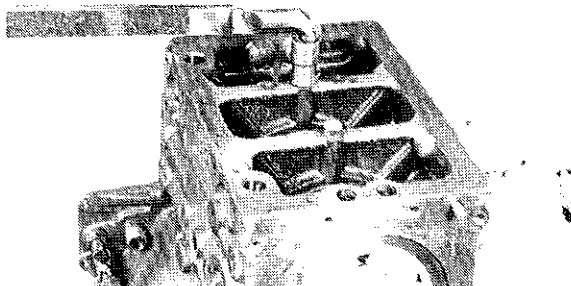

PB082

- Measure crankshaft end float.

103-09/10/Perama M25/M30

Standard play	Allowable limit
0.05-0.3mm (.002-.012")	0.5mm (.020")

103-06/07, M20, 102-04/05

Standard play	Allowable limit
0.1-0.3mm (.004-.012")	0.5mm (.020")

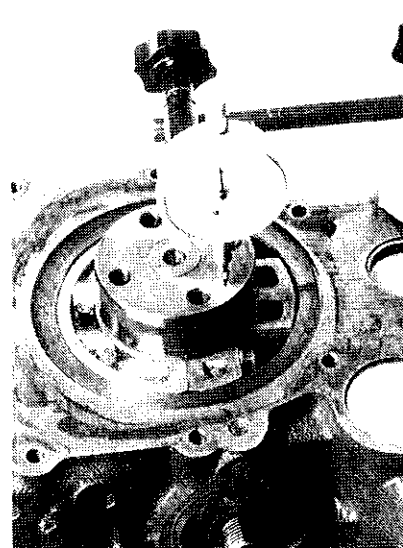

PB083

### Rear Oil Seal

- This is a pressfit, retained by the back plate.

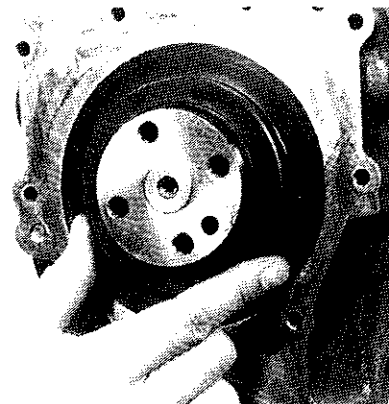

PB084

### Back Plate

- Coat the area around the M10 threaded holes with liquid packing solvent based sealant and fix the back plate with bolts.

Back plate tightening torque:

4.7 to 5.5kgf.m (34 to 40lb/ft) 103-09/10/  
Perama M25/M30.

1.3 to 1.7kgf.m (9 to 12 lb/ft) 102-04/05, 103-  
06/07, M20

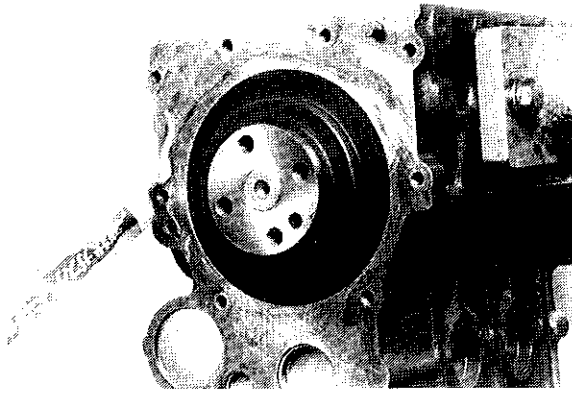

PB085

### Flywheel

- A. Fit the flywheel, note location of the spring pin.

Flywheel tightening torque:

6.0 to 7.0kgf.m (43 to 50lb/ft) 103-09/10/  
Perama M25/M30.

7.0 to 8.0kgf.m (51 to 58lb/ft) 102-04/05,  
103-06/07, M20.

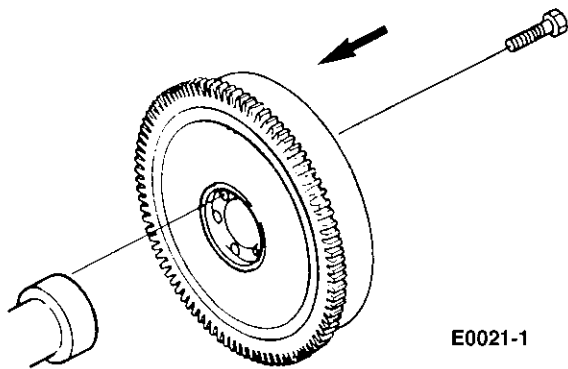

E0021-1

### Piston and Connecting Rod

- A. Coat bearing face, piston and piston ring with clean engine oil.
- B. Slide the piston ring to permit sufficient amount of oil to be applied in the groove. Set piston ring gaps 90 degrees apart from each other. However, do not position these gaps toward the gudgeon pin or the right angle of the pin.
- C. Insert the piston using a ring compressor. Face the reference mark (SHIBAURA) on the piston toward the injection pump side. (103-09/10/Perama M25/30) and the 'F' mark towards the front of the engine on the 102-04/05, 103-06/07, M20. Also face the connecting rod mark towards the fuel pump side.

103-06

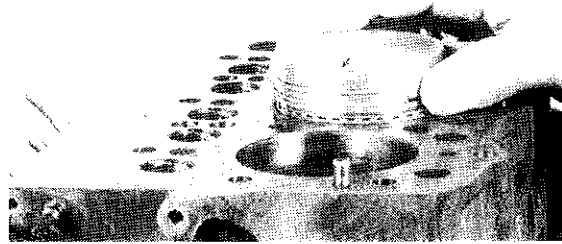

PB087

NOTE: Install pistons from front in ascending order.

- D. Tighten the connecting rod cap to specified torque.

Connecting rod tightening torque:

3.0 to 3.5kgf.m (22 to 25lb/ft) 103-09/10/  
Perama M25/M30.

2.1 to 2.6kgf.m (15 to 19lb/ft) 102-04/05, 103-06/07, M20.

NOTE: After installation ensure that the crankshaft moves freely. Ensure the axial play of 0.1 to 0.3mm (.004 to .012) is provided.

### Suction Pipe and Suction Filter

- A. Fix an O-ring on the suction pipe, and insert the pipe into the cylinder block.
- B. Fit the end of the suction pipe to the oil strainer and fix the oil strainer.

Suction filter tightening torque:

0.9 to 1.3kgf.m (6.5 to 10lb/ft).

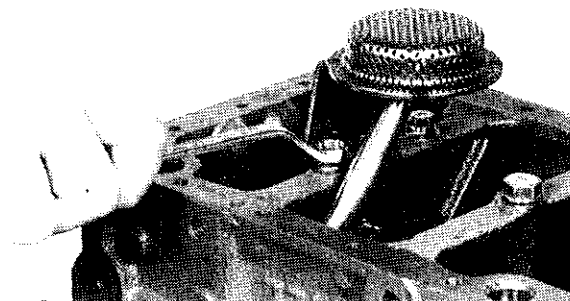

PB088

### Sump

- A. Tighten the bolts diagonally and evenly.

### Dipstick and tube

- A. Install the dipstick and tube using two O-rings.



## Front Plate

### Camshaft Assembly, Tachometer Shaft and Plate

- A. Install the tachometer shaft.
- B. Install the camshaft assembly. Avoid damaging bearings.
- C. Fix the tachometer shaft and camshaft with the retaining plate.

Plate tightening torque:  
0.9 to 1.3kgf.m (6.5 to 10lbf/ft).

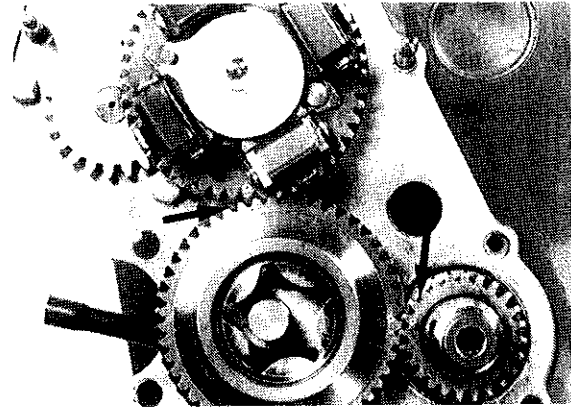

PB091

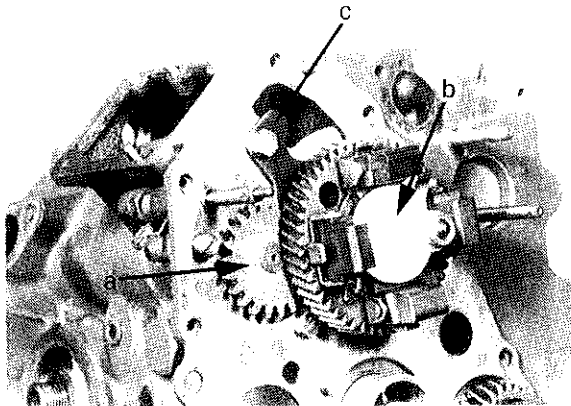

PB089

- D. Install the rotor.
- E. Install the oil pump cover, shim, spring and collar. Fix them with the circlip.

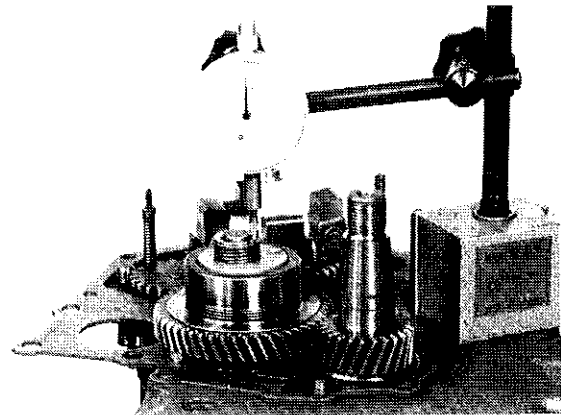

PB092

### Idle Gear and Oil Pump Assembly (See Section IV Oil Pump)

- A. Install the thrust washer on the idle gear shaft.
- B. Assemble the vane, knock pin and spring on the idle gear.

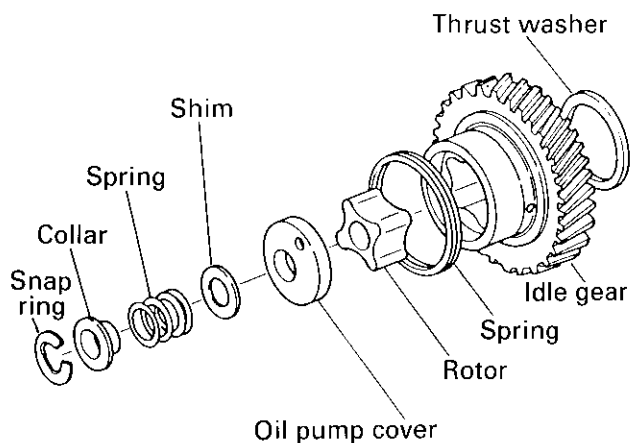

PB090

- F. Adjust with shim 0.1, 0.15, 0.2, 0.5mm so that the side clearance of oil pump, rotor and vane is in the range of 0.1 to 0.15mm.

NOTE: Coat both faces of the rotor and vane with grease for assembly.

NEVER TURN the crankshaft until the timing gear case is fitted.

By turning the oil pump cover to either direction, set the spring pin insert hole to the middle position. Then, fit the gear case.

- C. Align set marks on idle gear, crankshaft gear and camshaft gear, and assemble on the idle gear shaft.

### Timing Gear Case

- A. Install the start spring.
- B. Insert link through hole in cylinder block. Rotate oil pump cover to position spring pin hole to centre position. Install cover locating pin in oil pump cover plate. (PB094).

NOTE: 1. Do not damage the oil seal when fitting.

2. Turn the mechanical stop lever clockwise to assist assembly.

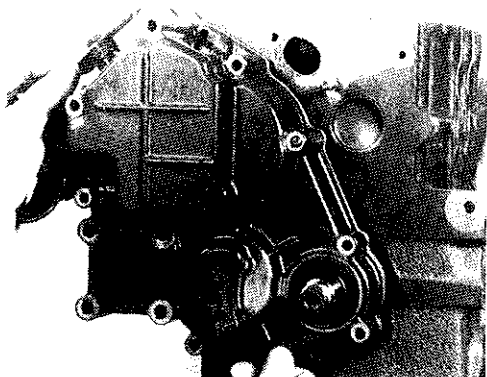

PB093

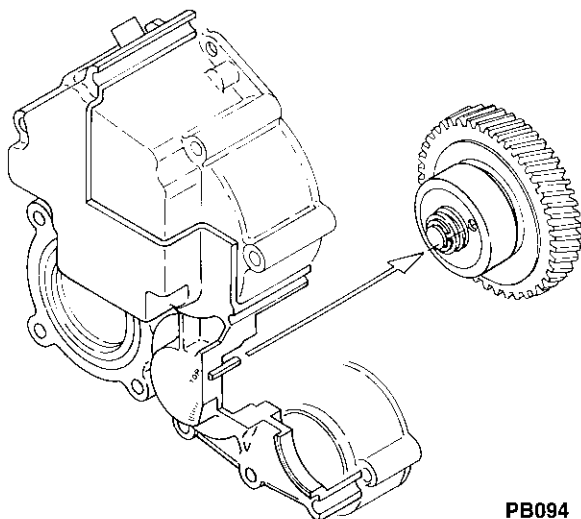

PB094

### Crankshaft Pulley

- A. Align the key way and key on the crankshaft pulley and crankshaft, and assemble them.

Crankshaft pulley tightening torque:  
12 to 13kgf.m (87 to 94lb/ft) 103-09/10/Perama  
M25/M30.

9 to 10 kgf.m (65 to 72lb/ft) 102-04/05, 103-06/  
07, M20.

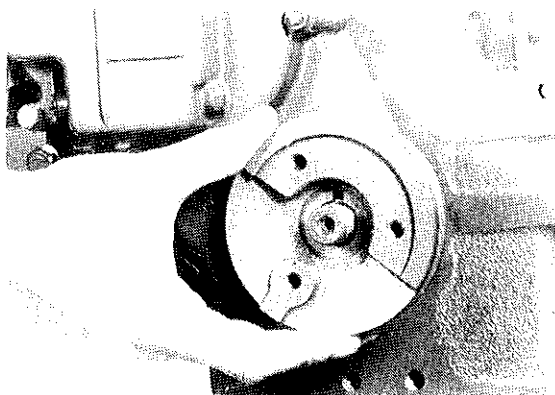

PB095

### Injection Pump Assembly

- A. Reinstall the shim. Connect the control rack of the injection pump with the link, and fix with the snap pin.
- B. Tighten the injection pump bolts and nuts.

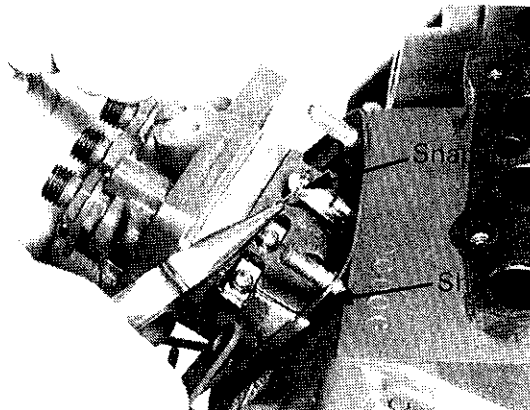

PB096

### Adjusting the Fuel Injection Timing

Normally this procedure provides correct injection timing. However, when new injection pump, camshaft assembly, or cylinder block is used, fuel injection timing should be adjusted as explained below.

- A. Reassemble the injection pump according to the procedures above. Use the shim of 0.5mm thickness.
- B. Remove the delivery valve holder at the front side (radiator side) of the injection pump.

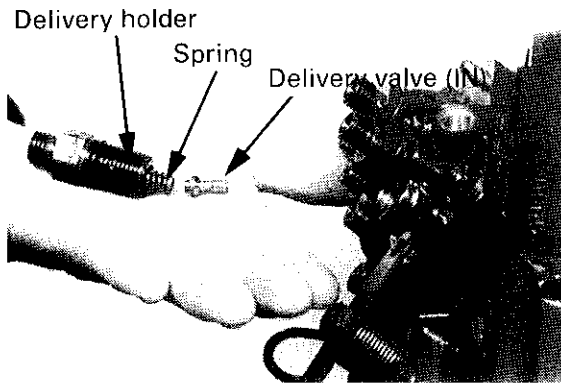

PB097

C. Pull out the delivery valve (IN), and reinstall the spring and delivery valve holder.

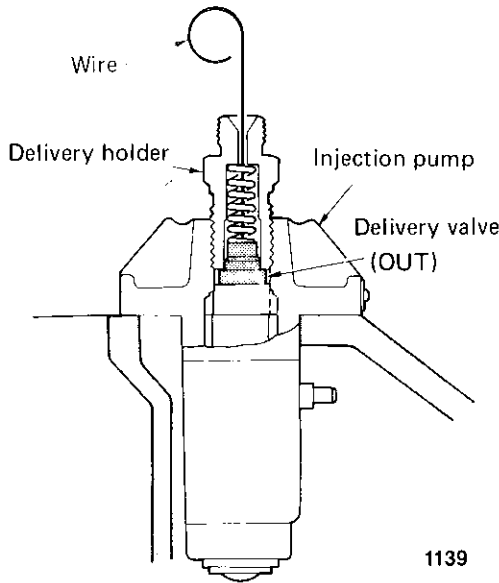

1139

NOTE: When re-assembling the delivery holder, adjust the location of the delivery valve (OUT) to correct position using a wire.

D. Move the governor control lever to "Maximum Fuel" position, and send fuel with the No 1 piston at around 'X' degrees BTDC in its compression stroke. At this time, fuel flows from the delivery holder.

Injection Timing and crankshaft positions

Engine Model	Degrees Crank BTDC			
	X	Y	Z	Injection Timing
KC30233, 34 KD30245, 46	20	18	18	17.5-19.5
KC30229, 30, 35, 36 KD30241, 42, 47, 48	23	22	22	21.5-23.5
KC30225, 26, 27, 28, 31, 32 KD30237, 38, 39, 40, 43, 44	24	23	23	22-24
KB30221, 22	28	25	27	24.5-26.5
KB30216, 17, 18, 23, 70	29	26	28	25.5-27.5
KB30219, 20, 24, 71	30	27	29	26.5-28.5
KA30213, 14, 15 83, 86, 89 KA30284, 85, 90	28	25	27	24.5-26.5
	30	27	29	26.5-28.5

E. Then slowly turn the crankshaft clockwise until flowing fuel from delivery holder is stopped. Check the piston position at this point. If the position is later than 'Y' BTDC, use thinner shim. If the position exceeds 'Z' BTDC, use thicker shim.

Piston Position in relation to the crankshaft angle (BTDC)

102-04 (KA lists), 102-05 (KN lists), 103-06 M20 (KB lists), 103-07 (KL lists)		103-09/10/Perama M25/M30 (KC, KD lists)	
Crankshaft angle (BTDC)	Position mm (inch)	Crankshaft angle (BTDC)	Position mm (inch)
24	3.636 (.1431")	14	1.409 (.0555")
25	3.937 (.1550")	15	1.615 (.0636")
26	4.250 (.1673")	16	1.836 (.0723")
27	4.573 (.1800")	17	2.069 (.0815")
28	4.906 (.1931")	18	2.317 (.0912")
29	5.251 (.2067")	19	2.577 (.1015")
30	5.605 (.2224")	20	2.851 (.1122")
31	5.965 (.2348")	21	3.138 (.1235")
32	6.341 (.2496")	22	3.438 (.1353")
		23	3.750 (.1476")
		24	4.075 (.1604")
		25	4.413 (.1737")
		26	4.763 (.1875")
		27	5.125 (.2018")

Changing the shims thickness by 0.1mm will change the timing approximately one degree. Adding shims decreases the angle while subtracting shims increases the angle.

Injection timing adjusting shim

Thickness (mm)	103-06/07/09/10 Perama M20/M25/M30	
	Part Number	Part Number
0.2	131437310	131437381
0.3	131437320	131437391
0.4	131437330	131437401
0.5	131437340	131437411

NOTE: When the shim is not needed, assemble by coating using liquid sealant.

F. Assemble the delivery valve (IN).

NOTE: Delivery holder tightening torques:  
102-04/05, 103-06/07, M20  
3.5-3.9kgf.m (25-28lb/ft).  
(103-09/10/Perama M25/M30)4.0-4.5kgf.m  
(29-33lb/ft).

Oil Filter

- A. Coat the mounting face with a thin film of oil, and hand tighten.

Feed Pump

- A. Insert using securing bolts.

Tappet

- A. Coat the tappet with oil, and assemble.

Cylinder Head

- A. Set the piston to the top dead center, measure the amount of protrusion above the cylinder block with depth gauge or dial gauge.

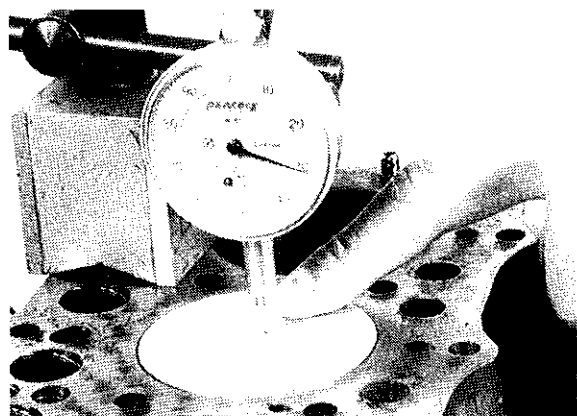

PB099

NOTE: Take measurement by pressing the piston lightly. Measure the protrusions for three cylinders. And, use the highest reading as a reference.

- B. Ensure the cylinder head gasket meets the tolerance levels.

103-09/M25

Measurement (mm)	Gasket No.	Tightened thickness
0.55-0.75 .0216-.0295"	103-09 111147250	t=1.3

103-10/M30

Measurement (mm)	Gasket No.	Tightened thickness
0.45-0.75 .0177-.0295"	103-10 111147280	t=1.3

103-06/M20

Measurement (mm)	Gasket No.	Tightened thickness
0.75-0.85 (.0295-.0335)	103-06 111147110	t=1.3
103-07 -0.25~-0.15	111147400	t=0.5
102-04 0-0.13	111147300	t=0.5
102-05 -0.15~+0.05	111147480	t=0.6

NOTE: Last four digits of code numbers are stamped on the head gasket. Install the head gasket with code numbers at top.

- C. Tighten the cylinder head in 3-step procedures, in the order shown in the illustration. Finally tighten with specified torque.

Specified torque:

5.0 to 5.3kgf.m (36 to 38lb/ft) 103-09/10/Perama M25/M30.

3.5 to 4.0kgf.m (25 to 29lb/ft) 102-04/05, 103-06/07, M20.

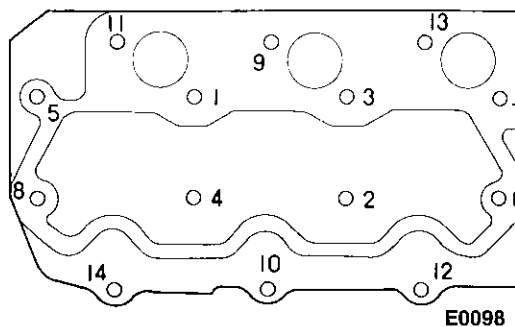

E0098

103-06/07/09/10  
Perama M20/M25/M30

NOTE: Spring pin is used for positioning.

Coat threads of bolts with grease based with molybdenum disulphide.

102-04/05

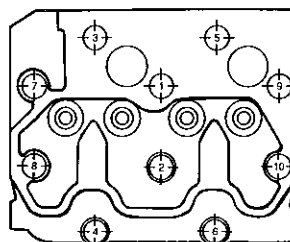

## Oil Pipe

Eyebolt tightening torque:  
1.0 to 1.3kgf.m (7.2 to 9.4lb/ft).

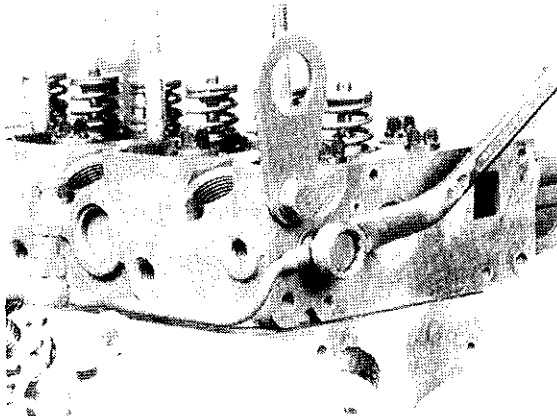

PB101

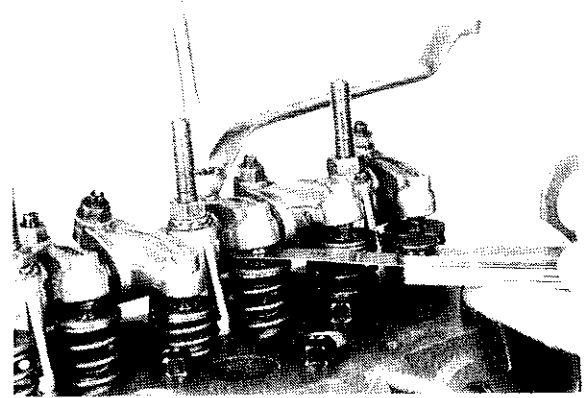

PB103

## Cylinder Head Cover

- A. Evenly tighten the cylinder head cover. Ensure gasket remains in location

Cylinder head cover tightening torque:  
1.0 to 1.2kgf.m (7 to 9lb/ft)

## Cap, Push Rod and Rocker Arm Assembly

- A. Install the cap on the end of valve stem.
- B. Install the push rod and rocker arm assembly.

Rocker arm assembly tightening torque:  
2.0 to 2.5kgf.m (14.5 to 18.1lb/ft).

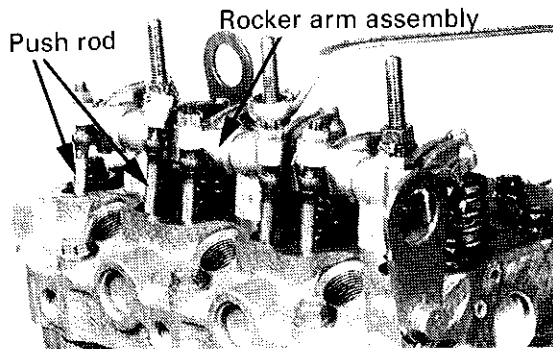

PB102

## Water Pump Assembly and Radiator Hose

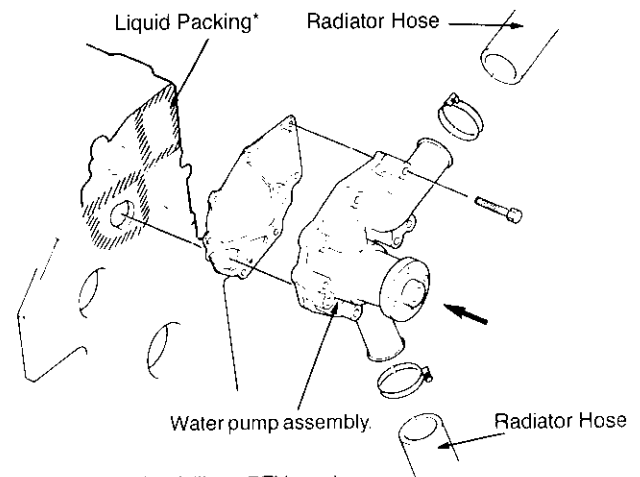

E0004-1

## Valve Clearance Adjustment

- A. Loosen the nut and adjust the clearance of both the intake and exhaust valves to 0.2mm (.0078") with the adjust screw.

### NOTE:

103-06/07/09/10

Perama M20/M25/M30:

Adjust when the engine is cold. Set the No.1 cylinder to the top dead center, and adjust the clearances of intake/exhaust valves of No. 1 cylinder and exhaust valve of No.2 cylinder. Then, turn the crankshaft counter-clockwise by 240° (viewed from the front) to adjust clearance of intake valve of No. 2 cylinder and intake/exhaust valves of No.3 cylinder.

102-04/05:

Adjust when the engine is cold. Set the No.1 cylinder to the top dead center, and adjust the clearances of intake/exhaust valve of No. 1 cylinder. Then, turn the crankshaft clockwise by 180° (viewed from the front) to adjust clearance of intake/exhaust valve of No.2 cylinder.

## Glow Plug and Connector

Glow plug tightening torque:  
1.5 to 2.0kgf.m (11 to 14.5lb/ft).

## Mano-Contact

Mano-contact tightening torque:  
1.5 to 2.0kgf.m (11 to 14.5lb/ft).

## Nozzle/Holder Assembly

- A. Install new cap and gasket securely ref. PB038. Install the nozzle and holder assembly with socket for the nozzle holder. Install the return pipe.

Nozzle/holder tightening torque:  
8 to 8.5kgf.m (58 to 62lb/ft) 103-09/10/Perama M25/M30.  
6 to 7kgf.m (43 to 51lb/ft) 102-04/05, 103-06/07, M20.

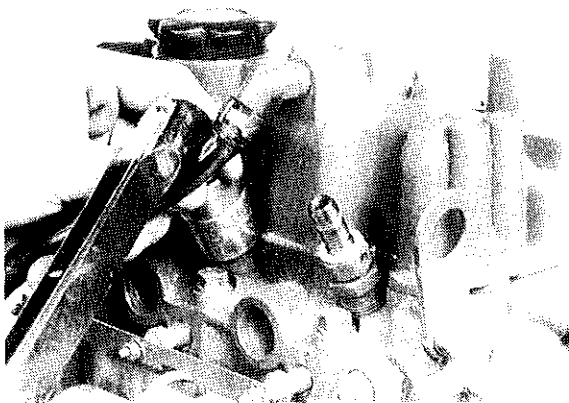

PB105

### Return Pipe and Injection Pipe

- A. After installing the return pipe, mount injection pipes.

Injection pipe tightening torque:  
2.0 to 2.5kgf.m (14.5 to 18lb/ft).

### Alternator Assembly

- A. Install the assembly. Check belt groove alignment.

### V Belt, Fan Pulley and Cooling Fan

- A. After mounting the fan pulley and cooling fan, install the V belt.
- B. Depress the belt at the center between the crankshaft pulley and the alternator pulley, with finger force of approximately 5kg (2.27lb/ft). The fan belt tension should be adjusted such that the deflection becomes 5mm (.2") upon the above check.

Cooling fan tightening torque:  
0.9 to 1.3kgf.m (6.5 to 9.5lb/ft).

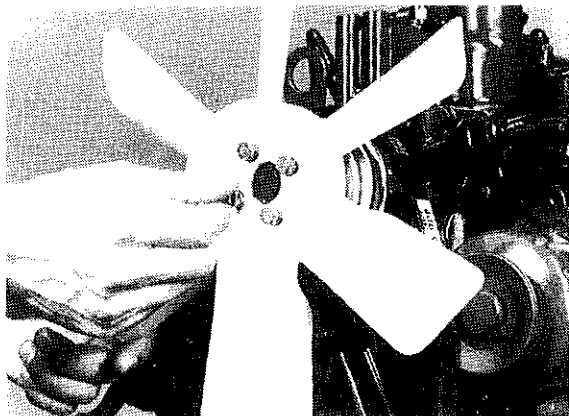

PB106

### HOW TO OPERATE THE ENGINE AFTER OVERHAUL

1. Check the quantity of the coolant, engine oil and fuel.
2. Disconnect the wiring harness connector at the engine stop solenoid.
3. Move the hand throttle lever to the low throttle position.
4. Turn the key switch to the start position (rotate the starting motor) until the oil pressure lamp goes off (about 20-30 seconds).
5. Connect the wiring harness connector at the engine stop solenoid.
6. Move the hand throttle lever to the half throttle position and start the engine.
7. Adjust the low speed engine running and warm up for 30 minutes, and check at the same time as follows:
  - Check for abnormal sound.
  - Check temperature of coolant.
  - Check temperature of engine oil.
  - Check leak of engine oil, coolant and fuel.
  - Check colouring of exhaust gas.

A gradual running-in of overhaul engine is necessary for delivery of the lubricating oil to each bearing etc.

# SECTION VI Electrical Systems

## Alternator

N.B. (Perama M25/M30 Lucas A127 - see Section 10).

### - Specification and Performance

103-09/10

Type	GP9150
Direction of rotation	Clockwise (Viewed from pulley)
Speed	1300-6000rpm
Charging capacity	15-16.5A at 14V at 5000rpm
Minimum charging speed	Less than 1600rpm (at 13V)
Regulator	RS5101
Part number	185046160

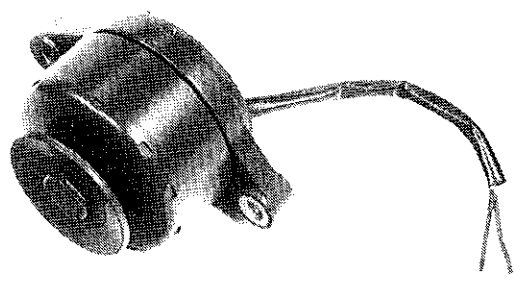
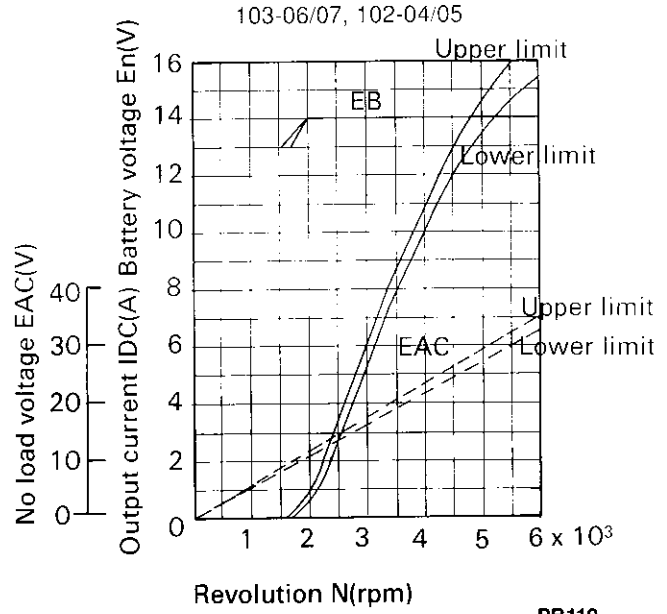

**PB118**

103-06/07 102-04/05

Type	GP8146
Direction of rotation	Clockwise (Viewed from pulley)
Speed	1600-5600rpm
Charging capacity	14-15A at 14V at 5200rpm
Minimum charging speed	
Regulator	RS5101
Part number	185046160

103-09/10

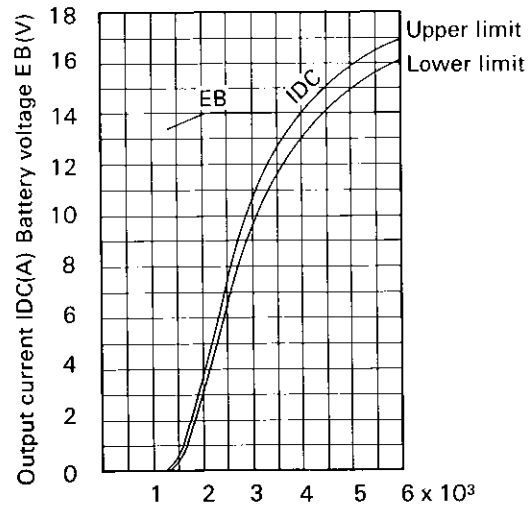

### - Construction

The alternator consists of the stator (armature coil and coil plate) and the flywheel which contain ferrite magnets.

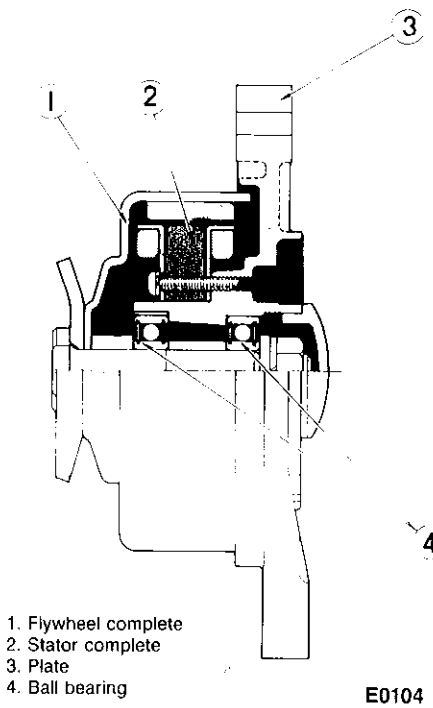

E0104

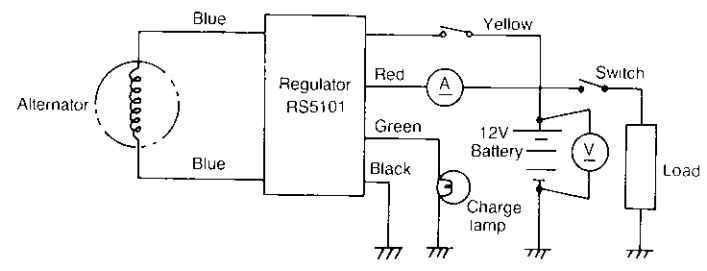

PB121

**Inspection**

- A. Connect an ammeter and a voltmeter as shown (PB121) and check the relation of the charging current with the terminal voltage.

**102-04/05, 103-06/07 Tests:**

	Normal	Abnormal	Cause
Relation between charge current and battery terminal voltage (at alternator 5200rpm)	1. More than 14A at 14V	More than 14A at battery voltage more than 15V	Improper operation of regulator
	2. 14A-0.5A at 14-15V	Charge current 0A	Defective alternator or regulator or improper connection
		Flowing charge current but low battery voltage	Defective battery (overdischarge)

**Alternator Performance of unit alone**

	Normal	Abnormal	Cause
No load voltage (between blue and blue) tester reading at operation (about 5200rpm)	More than AC 28V	Less than AC 28V AC 0V	Demagnetized flywheel, disconnected coil or wiring harness
Tester continuity	Between blue and blue of lead wire	Continuity observed	Continuity not observed
Insulation resistance (between a lead wire and coil plate)	More than 3MΩ	Less than 3MΩ	Improper coil insulation



**103-09/10 Tests:**

	Normal	Abnormal	Cause
Relation between charge current and battery terminal voltage (at alternator 5000rpm)	1. More than 15A at 14V	More than 15A at battery voltage more than 15V	Improper operation of regulator
	2. 15A-0.5A at 14-15V	Charge current OA	Defective alternator or regulator or improper connection
		Flowing charge current but low battery voltage	Defective battery (overdischarge)

Alternator Performance of unit alone

		Normal	Abnormal	Cause
No load voltage (between blue and blue) tester reading at operation (about 5000rpm)		More than AC 30V	Less than AC30V AC 0V	Demagnetized flywheel, disconnected coil or wiring harness
Tester continuity	Between blue and blue of lead wire	Continuity observed	Continuity not observed	Disconnected coil
Insulation resistance (between a lead wire and coil plate)		More than 3MΩ	Less than 3MΩ	Improper coil insulation

**B. Inspection of Flywheel**

Turn the flywheel by hand. If 12-time resistance due to magnetic force is experienced in one turn, and turns relatively smoothly, there is no trouble in the flywheel.

If noise is heard during rotation, the bearing is defective. Replace the bearing.

If the flywheel turns without any resistance, the magnetic force is too weak.

The magnet should be replaced with new.

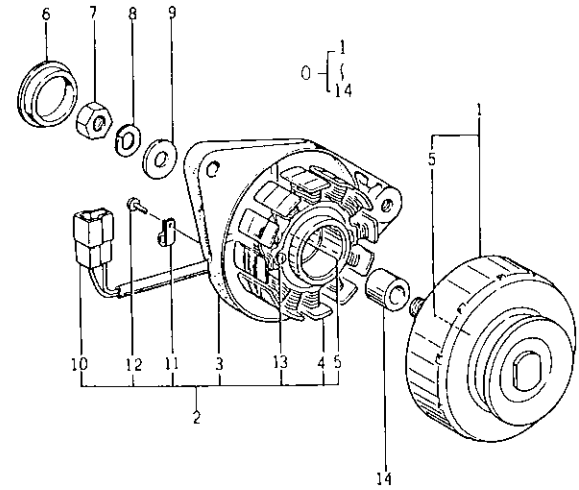

**- Disassembly**

When the alternator is defective or the flywheel turns abnormally, disassemble the alternator as explained below.

- A. Remove the dust cap (6) using a screw driver.
- B. Hold the pulley side jaw of the flywheel complete (1) with a vice, loosen the nut (7).
- C. Pull out the spring washer (8) and washer (9).
- D. Pull out the flywheel complete (1). If it is hard to remove, tap the M10 threads with a plastic hammer.

- |                      |                  |
|----------------------|------------------|
| 1. Flywheel complete | 8. Spring washer |
| 2. Plate complete    | 9. Washer        |
| 3. Coil plate        | 10. Coupler      |
| 4. Stator complete   | 11. Clamp        |
| 5. Bearing           | 12. Screw        |
| 6. Dust cap          | 13. Screw        |
| 7. Nut               | 14. Collar       |

- E. Disconnect the coupler (10) terminal stopper from the plate complete.
  - F. Loosen the M4 screw (12) and remove the clamp.
  - G. Remove the M4 screw (13).
  - H. Pull out the stator complete (4) from the coil plate (3).
  - I. Position the coil plate (3) rear side on a surface plate, and insert a rod having diameter of approximately 24mm. Then push the bearing with a press to remove. (Replace the front bearing as a flywheel complete).
- NOTE: NEVER CLAMP the flywheel body with any vice.
- J. Rotate the bearing manually to confirm that it rotates without noise.

**- Reassembly**

- A. Reassemble the alternator in the reverse of order of its disassembly, paying attention to the following precautions.
  - a. When installing the bearing, place the bearing housing side of the coil plate (3) on the flat plate. Then press the bearing from rear side of the coil plate using a rod of 31mm diameter. (Apply a rod on the outer face of the bearing.)
  - b. Tighten the nut (7) with the torque of 2.5 to 3.0kgf.m.
  - c. Clamp the flywheel complete.
  - d. Never suspend the alternator from a lead wire.

**Regulator**

**- Specification**

Type	RS5101
Part No.	185516060
Weight	Approx. 250 gram
Applicable battery	12V
Charging lamp	12V less than 3.4W
Applicable alternator	No-load voltage of less than 70V Output current of less than 16A
Adjusted voltage	14.5±0.5V

**- Inspection**

- A. Adjusted voltage  
Refer to "Inspection of Alternator".
- B. Unit inspection of regulator  
With circuit tester, carry out the inspection as shown in the separate table.

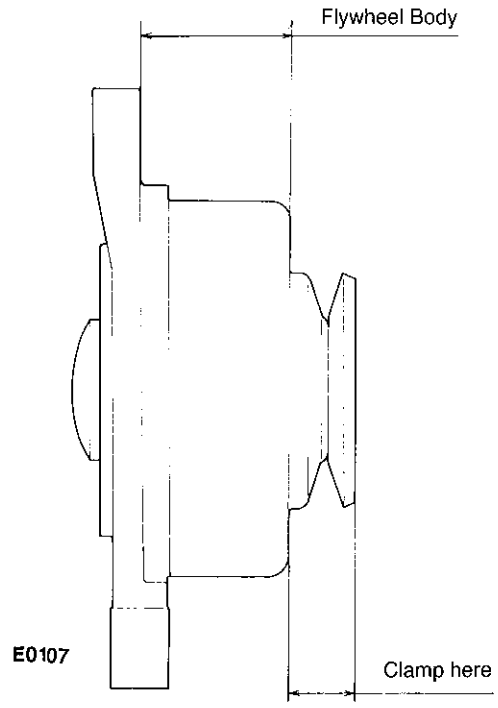

RS5101 Tester Checking table.

Tester (+) terminal Tester (-) terminal	Colour of cable					
	Blue	Blue	Red	Yellow	Green	Black
Blue		OFF	ON	OFF	OFF	OFF
Blue	OFF		ON	OFF	OFF	OFF
Red	OFF	OFF		OFF	OFF	OFF
Yellow	ON	ON	ON		OFF	ON
Green	OFF	OFF	OFF	OFF		OFF
Black	OFF	OFF	OFF	OFF	OFF	

NOTE: Set the tester at high resistance range.

'ON' denotes the fluctuation of the tester needle while 'OFF' denotes no fluctuation of the needle.

If the above results are attained, the tester is in good condition. However, even when the above test results are obtained, there may be the case that the regulator is not able to function correctly due to deterioration. Please take care of the deterioration.

#### - Precaution Upon Handling

- As large current flows through the regulator generating heat, the regulator must be positioned to the specified location.
- Securely install the regulator so that bottom face of the regulator is in full contact with the heat radiating plate or to the body.
- Never remove the battery wiring during machine operation. If removed, damage of the safety monitor, etc. will occur.

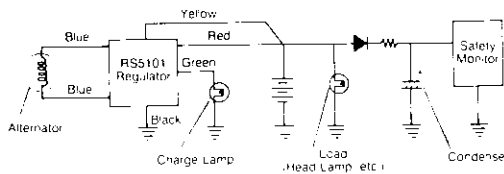

E0109

#### Starter motor

##### - Structure

The starting motor consists of a motor, magnetic switch, pinion and other component parts.

- Motor  
A DC series motor is used for this model, which provides large starting torque.

- Magnetic switch

The magnetic switch operates the plunger in the switch and engages the pinion via the shift lever. It opens and closes the points to start and stop the starting motor.

- Pinion

The pinion transmits the rotation of the motor to the engine. The pinion is provided with an overriding clutch to interrupt the power from the engine when the engine starts.

The overriding clutch composes of a rotor and clutch outer. The rotor is always pushed by the roller spring and the clutch outer is tapered where the roller is housed. When the rotor rotates in a direction that the roller enters the wider part, the pinion and clutch outer turn idly, but, when the roller rotates in the narrower part, the roller works as a key to transmit the rotation.

#### - Operation and Performance

- Put on the starting switch
- Electric current flows to the magnetic switch, a shunt coil and series coil, the plunger is attracted and the shift lever pushes out the pinion.
- The pinion is engaged with the ring gear.
- The contactor comes in contact, current flows to the starting motor, and the motor rotates to start the engine.
  - When the teeth of the pinion and ring gear run against each other, the pinion sleeve spring is compressed and plunger moves.
  - The contactor comes in contact, current flows directly from the battery to the motor to rotate the armature and the pinion engages with the ring gear.
  - The pinion engages with the ring gear completely to turn the ring gear.

#### Starter Motor Specifications

Model	Rated Time (sec.)	Output (kw)	Weight (kg)	Revolution direction (viewed from the pinion side)	Clutch system	Engaging system
S114-381	30	1.2	5.9	Clockwise	Overrunning	Magnetic shift

Model	Pinion pushing voltage (V)	Non-loading			Loading		
		Terminal voltage (V)	Current (A)	Revolution speed (rpm)	Terminal voltage (V)	Current (A)	Torque (kg-m)
S114.381	8 or less	12	60 or less	6000 or more	5	540 or less	1.6 or more

N.B. Model M003T32589 has output 0.7kw 12V and is Series wound.

- E. Engine starts.
- F. After the engine starts, return switch to run mode.
- G. The magnetic switch loses attracting force, the pinion returns by the return spring with the shift lever and disengaged, and the motor stops.

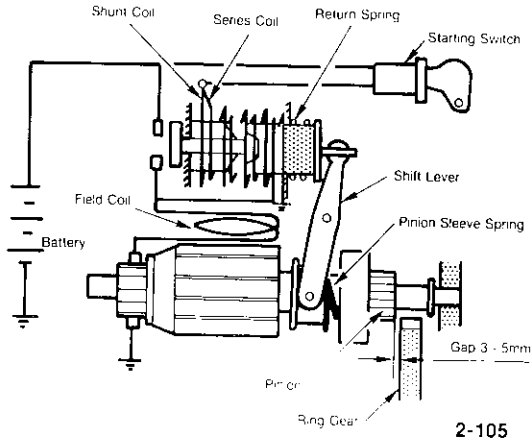

Connecting diagram.

**- Handling Method**

- A. Fix the gear case firmly to the engine side so that it is not affected by the large impact when the motor starts.

Standard gap between the pinion and ring gear is 3-5mm.

Use a wire of specified thickness and tighten it firmly. Insufficient tightening causes larger contact resistance and makes starting difficult.

- B. Precautions for starting
  - a. Ensure battery is charging. Insufficient charging will make starting more difficult.
  - b. After the engine has started, turn switch to run mode.
  - c. When it is difficult to start the engine by the starting switch, turning it frequently will decrease the battery electricity. In such a case, turn off the switch once and then keep it on for about 10 seconds. Repeat this procedure several times.
  - d. Never turn on the starting switch while the engine is operating.

**- Disassembly and Reassembly (Typical)**

- A. Remove the solenoid (magnetic switch).

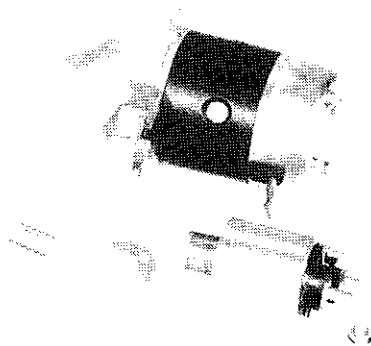

PB107

- B. Remove the dust cover and take out the E ring and thrust washer, where fitted. Remove the rear cover and brush holder.

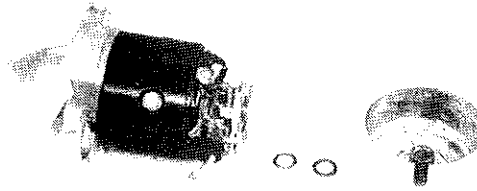

PB108

- C. Remove the bush assembly and yoke.

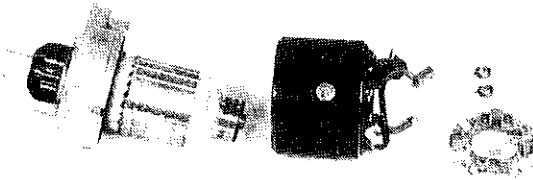

PB109

- D. Remove the shift lever and armature.

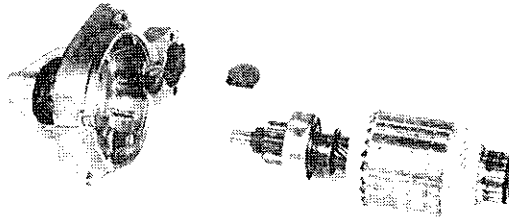

PB110

- E. Remove the pinion, as shown by first removing the snap ring ref PB111. Re-assembly by using puller as shown in PB112.

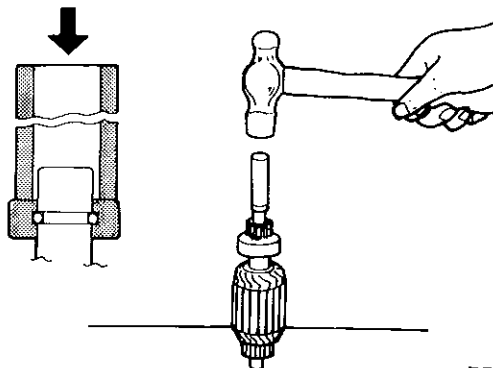

PB111

- Inspection and Service

A. Armature

- a. Short-circuit test of the coil  
Use a growler tester for the test. Place the armature core in a growler tester and, applying an iron piece, turn the armature. Vibration of the iron piece indicates short-circuit. Then replace the armature.
- b. Check the insulation between commutator and shaft. If continuity is indicated, it shows poor insulation. Then replace the coil. Proper measurement with a circuit tester is impossible. Be sure to use a 500 V megger for checking. If the test result is more than 1MΩ, it is acceptable.

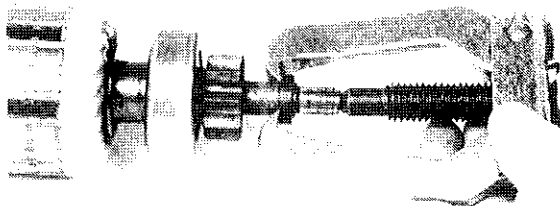

PB112

- H. Reassembly should be made in the reverse order of disassembling after inspecting as described in the paragraph of "Inspection and service". After assembling, check thrust gap for armature is 0.5mm maximum and then check and adjust the dimension, *i*.

Check and adjust the dimension, *i*.  
The distance for which the pinion is pushed out by the magnetic switch is called the dimension *i*. Measure the dimension *i* before installing the motor.

- a. Connect the (+) and (-) terminals of the battery to the S terminal of the magnetic switch.

NOTE: Use a 12V battery. Never short circuit (contact) (+) and (-).

- b. The pinion is inserted up to the pinion stopper.
- c. As shown in PB114, push the pinion to the arrow direction by finger so that there is no play and measure the dimension *i*.  
*i* = 0.2~1.5mm (1.2kw motor) and 0.5 to 2.0mm on 0.7kw motor. Loosen the adjusting nut and adjust by the adjusting screw, or shims where fitted.

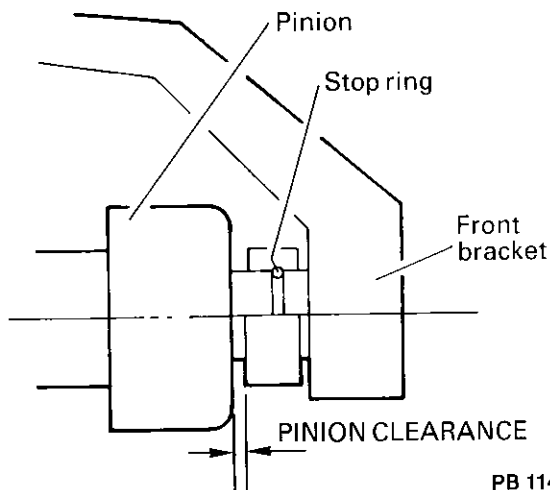

PB 114

- d. Check operation of magnetic switch and change adjusting plate if necessary.

- c. Inspection of the surface of commutator

The part of the commutator surface where the brush is sliding in contact can be distinguished clearly. If the sliding area is rough, grind with sand paper of No. 500 or 600. If the indication of a dial gauge exceeds 0.5mm (.002"), correct with a lathe.

- d. Insulator of the commutator

Measure the depth of the insulator of the commutator, and correct as indicated in PG144 if the result is 0.2mm (.008") or less.

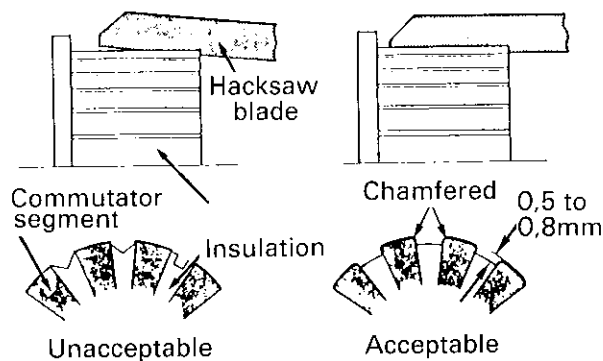

PG144

- e. Shaft bend

Measure the bend of the shaft with a dial gauge. Holding the center of the armature shaft ends, measure the run-out of the center bearing metal. Turn the armature quietly and read the value indicated by the dial gauge pointer. Real bend is 1/2 of the reading. Allowable bend limit: 0.08mm (.003")

B. Field Coil

- a. Check the field coil for disconnection using a tester. Inspect the continuity between terminals connected with a brush of the field coil. If no continuity is indicated on the tester, it shows disconnection. Then replace the field coil with new one.

- b. Check the continuity between the field coil and yoke with a tester. Inspect the continuity between either terminal of the field coil and yoke. Continuity shows insufficient insulation. Then replace the coil.

#### C. Movement of the brush

- a. Check movement of the brush. When the brush does not move smoothly, check the bend of the brush holder and stain on the sliding surface of the brush holder, correct and clean.
- b. Check the insulation between the brush holder (⊕ side) and holder base (⊖ side... earth). If continuity is indicated, it shows insufficient insulation. Then replace the brush with new one.
- c. Allowable wear limit of the brush is:  
1.2kw motor 12mm (New 16mm)  
0.7kw motor 11.5mm (New 17mm)
- d. Measurement of the tension of the brush spring.

Standard tension is 1.6kg to 2.0kg.  
Set the brush spring and pull up with a spring balance and measure the load when the brush is raised up.

Replace a faulty spring with new one.

Service limit: 1.2kw motor 1.4kg; 0.7kw motor 0.9kg.

#### D. Magnetic switch

- a. Check the shunt coil for disconnection. Inspect the continuity between the magnetic switch S terminal and coil case (metal part). If continuity is not indicated, it shows disconnection. Then replace the switch with new one.

#### - Troubleshooting

- A. The pinion does not move when the starting switch is on.
- B. Check the series coil for disconnection. Inspect the continuity between the magnetic switch S terminal and M terminal. If no continuity is indicated, it shows disconnection. Then replace the coil.
- C. Pinion
- a. Check the pinion teeth for wear and other damages. Replace faulty pinion.
- b. Check the pinion for smooth sliding. If scratches or burr is found on the pinion metal, replace the pinion.
- c. If the clutch freewheels in both directions or seizes when spun by hand, replace. Do not clean in solvent.

Position	Cause	Remedy
Wiring	Disconnection, loosened terminals of the battery and switch	Repair and retighten
Starting switch	Insufficient contact. No current flows.	Repair the contact area or replace
Starting motor	Pinion-engaged screw part of the armature shaft is tucked and the pinion does not move.	Replace
Magnetic switch	Irregular movement of the magnetic switch plunger, disconnection or short circuit.	Repair or replace

(2) Pinion is engaged, motor rotates, but the engine does not start.

Position	Cause	Remedy
Starting motor	Faulty overrunning clutch	Replace

(3) Pinion is engaged with the ring gear but starting motor does not start.

Position	Cause	Remedy
Wiring	Disconnection of the wire connecting the battery and magnetic switch or insufficient fastening of the wire connecting the earth, magnetic switch and motor terminal.	Replace, retighten or replace the wire
Starting motor	Insufficient engagement of the pinion and ring gear Incorrect installation Worn out brush, faulty contact of the brush spring Stained commutator Faulty armature and field coil Insufficient connection of the field coil and brush	Replace Reinstall Replace Correct Repair or replace Retighten
Magnetic switch (solenoid)	Insufficient contact of the contactor Rough contact surface of the contactor	Replace Replace

(4) The motor rotates at full speed before the pinion engages with the ring gear.

Position	Cause	Remedy
Starting motor	Fatigued pinion sleeve spring	Replace

(5) After the engine starts, the motor does not stop when the starting switch is off.

Position	Cause	Remedy
Starting switch	Faulty switch	Replace
Magnetic switch	Faulty magnetic switch (solenoid)	Replace

**Glow Plug**

A sheathed type glow plus is employed and provides excellent starting.

**- Specification**

Part No. 185366060

Rated voltage	Current
10.5V	6.9A

**B. Short circuit**

The glow plug is of a simple structure and short circuit is rarely caused. However, if the central electrode, body, sheath, etc. come in contact, wiring of preheating circuit is burnt during starting.

Correction: Remove the connector and measure the resistance of each plug terminal and earth with a tester. The tester reading should be  $1.6 \pm 0.16\Omega$

Resistance of 0 indicates short circuit.

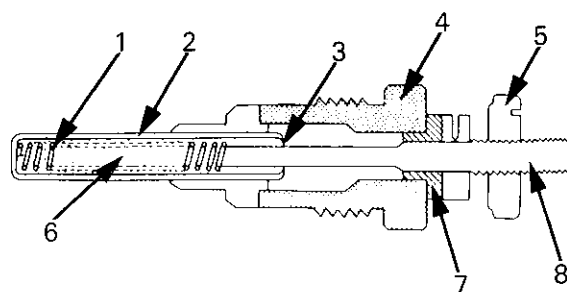

- 1 Heat wire
- 2 Sheath
- 3 Asbestos
- 4 Body
- 5 Nut
- 6 Magnesium oxide powder
- 7 Insulation bush
- 8 Core

Fig 2-124

**- Structure**

Coiled thin heat wire is placed in the sintered magnesium oxide powder enclosed by stainless sheath. One end of the heat wire is welded to the sheath end and the other end to the central electrode. By setting the starter switch to the position of Heat (H), the heat wire preheats the air in the combustion chamber.

**- Troubleshooting**

A. Disconnection of the heat wire.  
The glow plug operates even when any one of the heat wires is disconnected because it is connected in parallel. However, when disconnected, preheating time of the glow signal is extremely extended.

Check/Remove the connector and check the continuity between each plug terminal and body earth. If continuity is not observed, it shows disconnection. Then replace the heat wire.

**Thermoswitch**

**- Specifications**

Part No.	385720230
Type	TB-121B
Operating load	12V-3W
Switching temperature	97 TO 103° C (Off to On)
Switching off temperature	90° C and higher

EARLIER ENGINES HAD DIFFERENT SWITCH

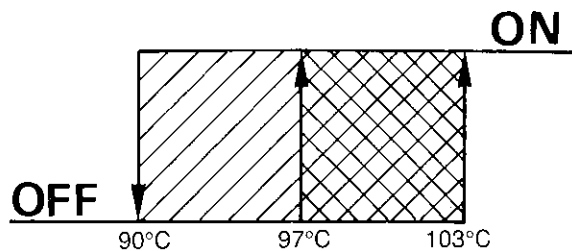

PB123

**Oil Pressure Switch**

Part No. 185246060

Oil pressure switch operating range:
0.2 to 0.4kg/cm <sup>2</sup> (2.8-5.7 psi)

A. The oil pressure switch is a warning device to inform low engine lubricating oil pressure. When oil pressure becomes less than specified the warning light is activated. This pressure switch houses a diaphragm and contact points. (MAX. CURRENT DRAW IS 0.42 AMPS)

**Battery****- Specifications (Typical)**

Type	N70 (12V)
Capacity	70AH
Specific gravity of electrolyte	1.26/20° when fully charged
Charging current	7 ampere (normal charging)

**Battery Charging State**

- A. Specific gravity of electrolyte is reduced linearly in proportion to the quantity of electricity discharged from the battery. Thus the specific gravity indicated by a hydrometer shows the residual capacity of the battery. The value indicated on the hydrometer should be corrected with respect to temperature. The gravity of electrolyte has been determined with 20°C as standard. It increases or decreases by 0.0007 as the temperature changes 1°C. Correct the value according to the formula indicated below.

$$S_{20} = S_t + 0.0007 (t-20)$$

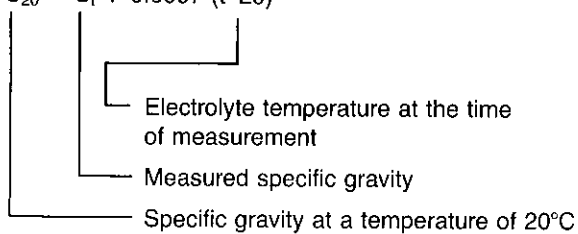

- B. Check the hydrometer with the eye level equal to the reading.

The relation between the specific gravity and residual capacity.

Specific gravity (20°C)	Quantity of electricity discharged (%)	Residual capacity (%)
1.260	0	100
1.210	25	75
1.150	50	50
1.110	75	25
1.060	100	0



# WIRING DIAGRAMS

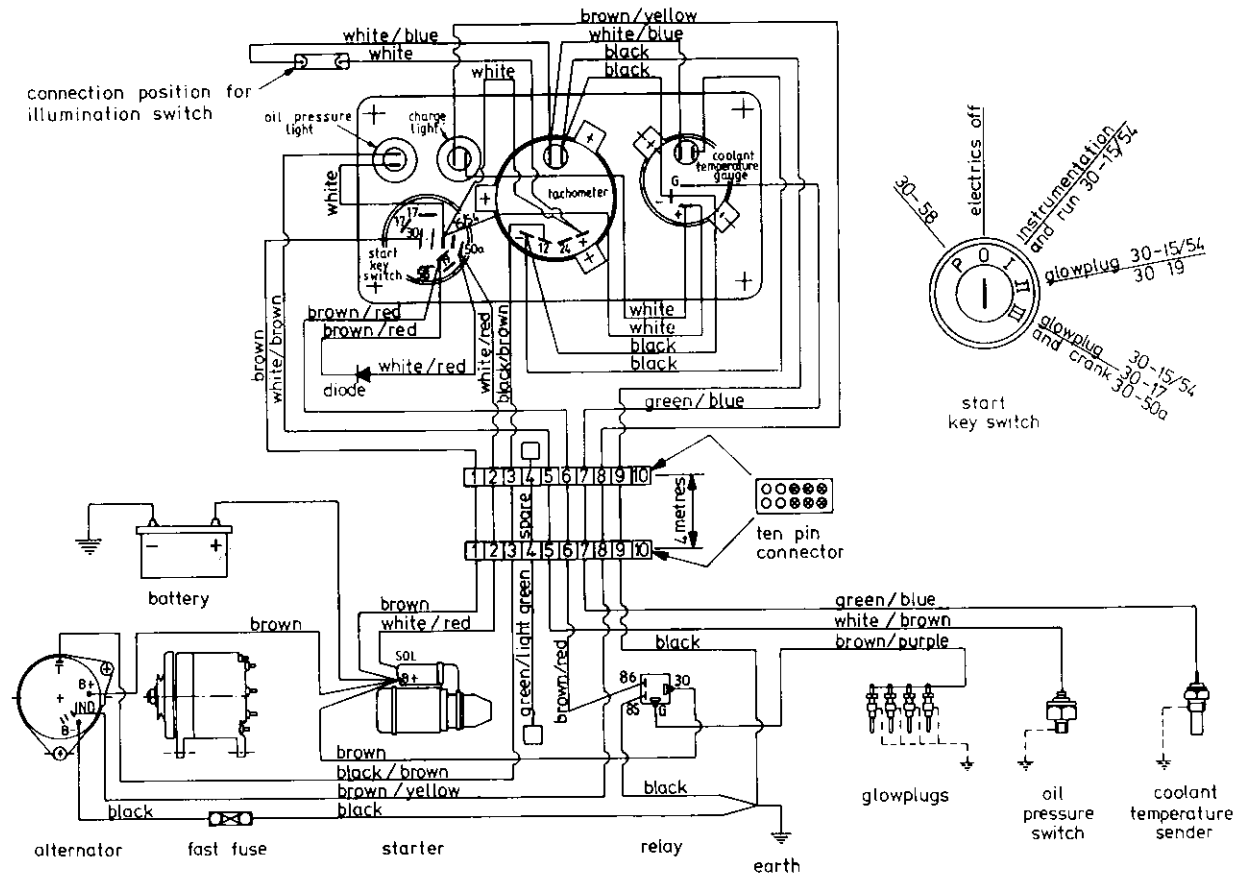

Perama Wiring Diagram

Wiring Diagram (102-04/05, 103-06/07, 103-09/103-10)

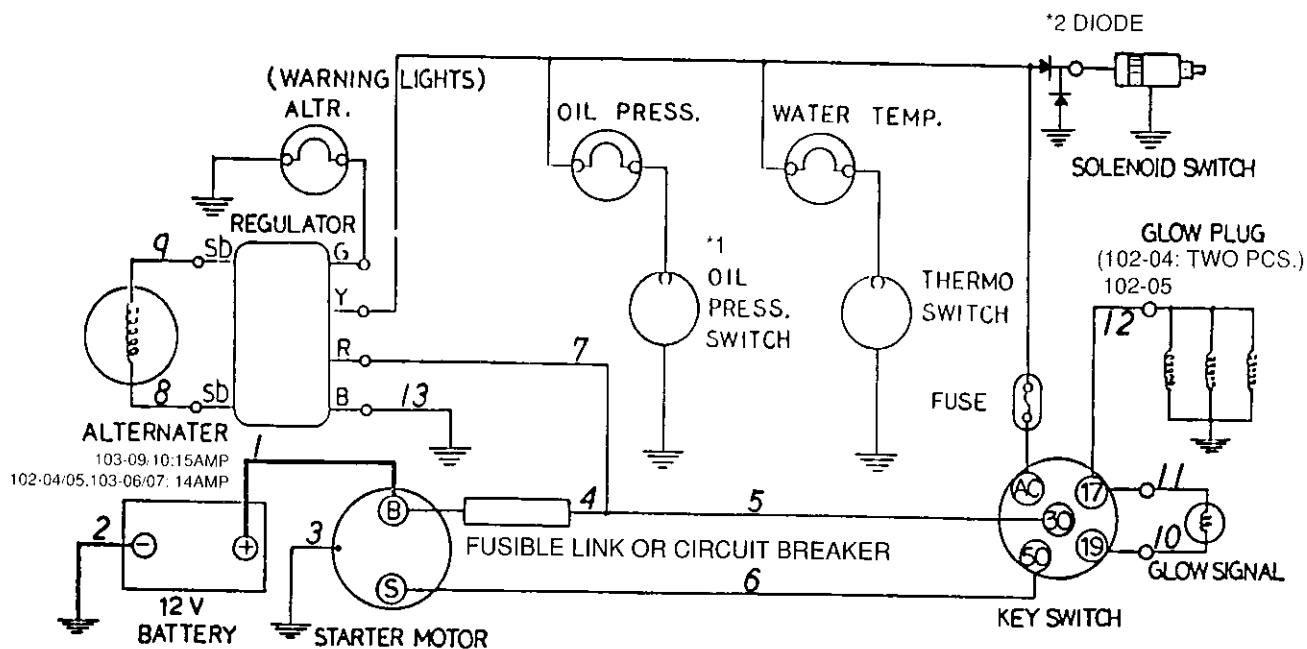

\*1. MAX CURRENT DRAW FOR STANDARD OIL PRESSURE SWITCH IS 0.42 amps (5 Watt max bulb)  
 \*2. DIODE Capacity: Current 3A. Reverse voltage 600V.

Wiring Diagram Maximum Circuit Resistance

Resistance of battery cables 1, 2 & 3 not to exceed 0.0018 ohm

Circuit	Cable No.	Circuit current	Maximum circuit resistance	Maximum circuit volt drop	Remarks
Alternator Charging	4 7, 8, 9, 13	15 amp	0.0333 ohm	0.5 volt	See glow plugs circuit
Starting Motor Solenoid	4 5 6	15.75 amp	0.04 ohm	0.63 volt	See glow plugs circuit See glow plugs circuit
Glow plugs (via glow signal)	4, 5, 10, 11, 12	27 amp	0.0185 ohm	0.5 volt	



# SECTION VII

## Trouble Shooting

### A. ENGINE DOES NOT START

CAUSE	REMEDY
Faulty key switch and or stop solenoid .....	Correct the connection and contact.
Insufficient charging or complete discharging of the battery .....	Charge.
Lack of fuel .....	Supply fuel.
Air mixed in the fuel system .....	Bleed the air.
Clogged fuel filter .....	Replace.
Irregular and faulty fuel supply (Injection pump trouble) .....	Repair in an authorized service shop.
Glow plug not heated .....	Breakage of the glow plug: replace.
Improper viscosity of the lubricating oil .....	Inspect and replace.
Clogged air cleaner .....	Clean.
No compression .....	Repair in a service shop.
Broken fusible link .....	Replace.

### B. IRREGULAR RUNNING OF THE ENGINE

CAUSE	REMEDY
Air mixed in the fuel system .....	Bleed the air.
Uneven fuel injection (Troubled fuel injection pump) .....	Repair at authorized shop.
Clogged fuel filter .....	Replace.
Defective governor .....	Check and correct.
Engine itself defective .....	Repair in a service shop.

### C. ENGINE STOPS DURING OPERATION

CAUSE	REMEDY
Lack of fuel in the fuel tank .....	Supply fuel and bleed air.
Clogged fuel filter .....	Replace.
Air mixed in the fuel system .....	Bleed the air.
Faulty function of the engine .....	Repair in a service shop.

### D. OVERHEAT OF THE ENGINE

CAUSE	REMEDY
Lack of cooling water .....	Supply water. Inspect leakage and correct.
Loosened or slipping fan belt .....	Remove oil, dust, etc. and tighten.
Damaged fan belt .....	Replace.
Clogged radiator .....	Flush the radiator.
Clogged radiator fin .....	Clean.
Dust or scale clogged in the cooling water passage .....	Flush the system.
Faulty function of the thermostat .....	Inspect or replace thermostat.
Lack of lubricating oil .....	Add oil.
Overloading .....	Decrease the load.

**E. GAS (WHITE OR BLUE) SMOKE**

CAUSE	REMEDY
Excess engine oil .....	Inspect and correct the level.
Too low viscosity of the engine oil .....	Inspect and replace the oil to correct one.
Faulty injection timing .....	Too late: correct.

**F. DARK GREY SMOKE**

CAUSE	REMEDY
Unsuitable fuel .....	Inspect and replace to correct grade.
Excess injection .....	Inspect and adjust (in a service shop).
Faulty function of the engine .....	Repair in a service shop.
Overloading .....	Reduce the load.
Clogged air cleaner .....	Clean.

**G. FAULTY CHARGING**

CAUSE	REMEDY
Loosened fan belt .....	Correct the tension.
Faulty wiring .....	Inspect and correct.
Faulty battery .....	Repair.
Worn out alternator brush .....	Replace.
Broken fuse .....	Replace.

**H. STARTER MOTOR DOES NOT RUN**

CAUSE	REMEDY
Loosened or disconnected wiring .....	Inspect and tighten.
Dropped voltage of the battery .....	Charge the battery.
Damaged starter motor .....	Repair in a service shop.
Broken fusible link .....	Replace.

**I. OIL PRESSURE LAMP NOT TURNED ON  
(KEY SWITCH 'ON' WITH ENGINE NOT STARTED)**

CAUSE	REMEDY
Broken lamp bulb .....	Replace the bulb.
Broken wire between battery to the lamp .....	Correct it.

**J. OIL PRESSURE LAMP NOT TURNED OFF**

CAUSE	REMEDY
Lack of engine oil .....	Supply oil up to the specified level.
Trouble in the pressure switch (mano-contact) .....	Replace the switch.
Oil leakage from the lubricating system .....	Inspect and retighten.
Clogged oil filter .....	Replace with new one.
Short-circuit between oil pressure lamp and mano-contact .....	Repair.

# SECTION VIII

## Service Standards

### 103-09, 103-10, Perama M25, M30

Unless otherwise stated 103-09 is equivalent to Perama M25  
103-10 is equivalent to Perama M30

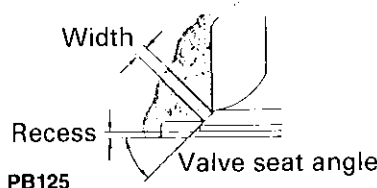
Inspection items	Standard Dimension	Standard Value	To Be Repaired	Allowable Limit	Remarks
<b>ENGINE</b>					
<b>CYLINDER HEAD</b>					
Compression pressure of cylinder kg/cm <sup>2</sup>		more than 30 (425 psi)	less than 25 (355 psi)		Engine 200rpm
Distortion of face of cylinder head		less than 0.05	more than 0.12		
Valve seat (Intake/exhaust)					
 <p>Width Recess Valve seat angle <b>PB125</b></p>		0.85-1.15 (.034-.045")	1.8 (.045")		Valve seat angle 45°
Width of valve seat (Intake/exhaust)		1.7-2.1 (.067-.083")	2.5 (.098")		
Tightening torque of cylinder head kg-m		5.0-5.3kgf.m (36-38lb/ft)			Coat threads with molybdenum bisul- fide based grease.
<b>CYLINDER BLOCK</b>					
Type 103-09		Dry type (single piece)			
Bore	72 (2.835")	71.99-72.005 (2.834-2.835")	72.2 (2.843")	73.2 (2.88")	Over size (0.5, 1.0) (.020/.040")
Type 103-10		Dry type (single piece)			
Bore	75 (2.952")	75-75.019 (2.95-2.954")	75.2 (2.960")	76.2 (3.0")	Over size (0.5, 1.0) (.020/.040")
Distortion of upper face of cylinder block		less than 0.05 (.002")	0.12 (.005")		
<b>PISTON 103-09</b>					
Skirt diameter (longer diameter)	72 (2.835")	71.9325-71.9475 (2.832-2.833")		71.7 (2.823")	Over size (0.5, 1.0) (.020/.040")
Clearance to cylinder		0.0525-0.0825 (.0021-.0033")		0.25 (.009")	20°C
Inside diameter of piston pin	21 (.826")	20.998-21.002 (.8267-.8268")			
Piston pin hole-to-pin clearance		-0.004+0.004 (-.0001-±.0001")		0.02 (.0007")	
<b>PISTON 103-10</b>					
Skirt diameter (longer diameter)	75 (2.952")	74.9425-74.9575 (2.950-2.951")		74.7 (2.941")	Over size (0.5, 1.0) (.020/.040")
Clearance to cylinder		0.0425-0.0665 (.0017-.0026")		0.25 (.009")	20°C
Inside diameter of piston pin	21 (.826")	20.998-21.002 (.8266-.8268")			
Piston pin hole-to-pin clearance		-0.004+0.004 (.0001-±.0001")		0.02 (.0007")	
<b>PISTON RING 103-09</b>					
Piston ring gap:					
No. 1 ring		0.15-0.27 (.0059-.010")		1.0 (.039")	
No. 2 ring		0.12-0.24 (.004-.010")			
Oil ring		0.2-0.35 (.007-.013")			

Inspection items	Standard Dimension	Standard Value	To Be Repaired	Allowable Limit	Remarks
<b>PISTON RING 103-09 (Continued)</b>					
Piston ring groove-to-ring clearance					
No. 1 ring		0.06-0.1 (.002-.003")		0.25 (.009")	
No. 2 ring		0.05-0.09 (.002-.0035")			
Oil ring		0.02-0.06 (.0007-.002")		0.15 (.006)	
Ring width					
No. 1 ring	2 (.079")	1.97-1.99 (.077-.078")			Over size (0.5, 1.0) (.020/.040")
No. 2 ring	1.5 (.059")	1.47-1.49 (.058-.059")			
Oil ring	4 (.157")	3.97-3.99 (.156-.157")			

**PISTON RING 103-10**

Piston ring gap:					
No. 1 ring		0.15-0.27 (.0059-.010")		1.0 (.039")	
No. 2 ring		0.12-0.24 (.004-.010")			
Oil ring		0.2-0.35 (.007-.013")			
Piston ring groove-to-ring clearance					
No. 1 ring		0.06-0.1 (.002-.003")		0.25 (.009")	
No. 2 ring		0.05-0.09 (.002-.0035")			
Oil ring		0.02-0.06 (.0007-.002")		0.15 (.006")	
Ring width					
No. 1 ring	2 (.079")	1.97-1.99 (.078-.078")			Over size (0.5, 1.0) (.020/.040")
No. 2 ring	1.5 (.060")	1.47-1.49 (.058-.059")			
Oil ring	4 (.157")	3.97-3.99 (.156-.157")			

**CONNECTING ROD**

Twist between small and large end holes (per 100mm)		less than 0.08 (.003")	0.2 (.0007")		
Straightness at 100mm between small and large end hole		less than 0.05 (.002")	0.15 (.006")		
Front-to-rear clearance between connecting rod and crank pin		0.1-0.3 (.004-.011")		0.7 (.0027")	
Connecting rod bearing-to-crank pin clearance		0.035-0.083 (.001-.003")		0.2 (.0007")	Oil clearance
Crush height of large end bearing		0.006-0.046 (.0002-.0018")			Crush height
Connecting rod bearing (inner diameter x width)	39 x 17.5 (1.535")				
Connecting rod bolt torque kg-m		3.0-3.5 (22-25lb/ft)			
Weight difference with piston gram		less than 10			
Crush height of small end bush		0.034-0.095 (.001-.0037")			

**CRANKSHAFT**

Diameter of journal	46 (1.81")	45.964-45.975 1.8096-1.810")		45.9 (1.807")	Under size (0.25, 0.5) (.010-.020")
Diameter of pin	39 (1.54")	38.964-38.975 (1.534-1.535")		38.9 (1.532")	Same to above

Inspection items	Standard Dimension	Standard Value	To Be Repaired	Allowable Limit	Remarks
<b>CRANKSHAFT (Continued)</b>					
Roughness, main journal and crank pin	1.6Z				
Crankshaft deflection		less than 0.03 (less than .001")	more than 0.06 (more than .002")		
Axial play of crankshaft		0.05-0.3 (.002-.012")		0.5 (.020")	
Thickness of thrust washer	2.0 (.080")	1.95-2.0 (.076-.080")		1.8 (.070")	
O.D. x I.D. of bush (journal metal)	46 x 50 (1.811-1.969")				Under size (0.25, 0.5) (.010-.020")
Crush height of bush (journal metal)		0.074-0.130 (.003-.005")			
Clearance between crankshaft and journal (bush)		0.039-0.106 (.0015-.004")		0.2 (.009")	Oil clearance
I.D. x O.D. of center bearing	46 x 50 (1.811-1.969")				Under size (0.25, 0.5) (.010-.020")
Clearance between crankshaft journal and center bearing		0.039-0.092 (.0015-.004")		0.2 (.009")	Oil clearance
Tightening allowance of center bearing		0.008-0.048 (.0003-.0018")			Crush height

### VALVE SYSTEM

#### CAMSHAFT

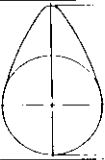
 Height	For intake/exhaust	26.445-26.5 (1.041-1.043")		26.1 (1.028")	
	For injection pump	33.94-34.06 (1.336-1.341")		33.8 (1.331")	
	For feed pump	27.9-28.0 (1.099-1.102")		27.0 (1.063")	
Backlash of cam gear		0.08 (.003")		0.3 (.012")	

#### VALVE

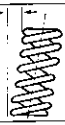
Diameter of intake valve stem			6.955-6.97 (.2738-.2744")		6.89 (.271")	
Diameter of exhaust valve stem			6.94-6.95 (.273-.274")		6.84 (2.69")	
Clearance between valve stem and valve guide	Inlet		0.03-0.06 (.001-.002")		more than 0.2 (more than .007")	
	Exhaust		0.05-0.75 (.002-.003")		more than 0.25 (more than .010")	
Thickness	 PB127	1.0 (.039")	0.925-1.075 (.036-.042")		0.5 (.020")	
Valve clearance (Intake/exhaust)			0.2 (.008")	0.5 (.020")		When cold
Valve spring	Spring strength (at 30.4mm compressed length) kg		8.1 (3.6lb/ft)		7 (3.2lb/ft)	
	Free length		35 (1.4")		33.5 (1.3")	
	Squareness	 PB128		less than 1.2 (.047")		2.0 (.079")
Inlet valve timing	Open-Before T.D.C.	13°				
	Close-After B.D.C.	43°				
Exhaust valve timing	Open-Before B.D.C.	43°				
	Close-After T.D.C.	13°				

#### PUSH ROD

Overall length	157 (6.18")	156.8-157.2 (6.173-6.189")			
Outer diameter	6.3 (.248")				



Inspection items	Standard Dimension	Standard Value	To Be Repaired	Allowable Limit	Remarks
<b>ROCKER ARM</b>					
Wear, rocker arm shaft	11.66 (.460")	11.65-11.67 (.459-.460")		11.57 (.456")	
Clearance between rocker arm and shaft		0.032-0.068 (.001-.002")		0.2 (.008")	Oil clearance

### LUBRICATION SYSTEM

#### OIL PUMP

Oil pressure switch operating pressure (kg/cm <sup>2</sup> )	0.3 (2.17lb/ft)	0.2-0.4 (1.45-2.89lb/ft)			
Relief pressure (kg/cm <sup>2</sup> ) psi.		3-5 (43-71)			
Tip clearance (rotor-to-vane)		0.01-0.15 (.0004-.006")		0.25 (.010")	
Side clearance (rotor-to-cover)		0.1-0.15 (.004-.006")		0.2 (.145")	

### FUEL SYSTEM

#### INJECTION PUMP KC30225, KC30226, KC30227, KC30228, KC30231, KC30232, KD30237, KD30238, KD30239, KD30240, KD30243, KD30244

Type	131017310				
Diameter of plunger	5.0mm				
Stroke of plunger	6mm				
Injection timing	Before T.D.C.	23°			
	Piston movement before T.D.C.	3.750mm (.1476")			

#### INJECTION PUMP KC30233, KC30234, KD30245, KD30246

Type	131017290				
Diameter of plunger	5.5mm				
Stroke of plunger	6mm				
Injection timing	Before T.D.C.	18°			
	Piston movement before T.D.C.	2.317mm (.0912")			

#### INJECTION PUMP KC30229, KC30230, KC30235, KC30236, KD30241, KD30242, KD30247, KD30248

Type	131017350				
Diameter of plunger	5.5mm				
Stroke of plunger	6mm				
Injection timing	Before T.D.C.	22°			
	Piston movement before T.D.C.	3.438mm (.1353")			

#### INJECTION NOZZLE

Type	131406330				
Injection pressure kg/cm <sup>2</sup>	120 (116 ats)	125-130 (121-130 ats)			103.09
Angle of injection direction	4°				103.10

### COOLING SYSTEM

#### COOLING

Cooling method	Water cooled forced circulation				
Thermostat open temperature (°C)	82	80-84			

Inspection items	Standard Dimension	Standard Value	To Be Repaired	Allowable Limit	Remarks
<b>COOLING (Continued)</b>					
Thermostat full-open temperature (°C)	87				
Pump discharge (lit/min) (at 2600rpm engine speed at cold)	40				
<b>ELECTRICAL SYSTEM</b>					
<b>STARTER MOTOR</b>					
Type	S114-381		185086321		
No. of teeth of pinion gear	9				
Shifting method of pinion	Magnetic				
Wear of commutator diameter	43 (1.7")			40 (1.6")	
Stepped wear of commutator		0.05 (.002")	0.4 (.015")		
Bending allowance of armature shaft			0.08 or more (.003")		
Length of brush	16 (.630")			12 (.472")	
Spring force of brush (kg)	1.6 (.727lb)			1.4 (.636lb)	
<b>ALTERNATOR</b>					
Type	GP9150		185046160		
Bend of rotor shaft			0.07 (.003")		
<b>REGULATOR</b>					
Type	RS5101		185516060		
Regulating voltage	14.5	14-15			

# 102-04, 102-05, 103-06, 103-07, M20 Service Standards

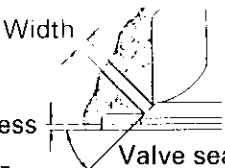
Inspection items	Standard Dimension	Standard Value	To Be Repaired	Allowable Limit	Remarks
<b>ENGINE</b>					
<b>CYLINDER HEAD</b>					
Compression pressure of cylinder kg/cm <sup>2</sup> (psi)		more than 30 (426.6)	less than 25 (355.5)		Engine 200rpm
Distortion of face of cylinder head		less than 0.05 (.002")	more than 0.12 (.0047")		
Valve seat (Intake/exhaust)		0.70-0.90 (.0256-.0354")	1.8 (.0709")		Valve seat angle 45°
 <p>Width Recess Valve seat angle</p>					
<b>PB125</b>					
Width of valve seat (Intake/exhaust)		1.59-1.80 (.0626-.0709")	2.5 (.098")		
Tightening torque of cylinder head kg.m (lb/ft)		3.5-4.0 (25.3-28.9)			Coat threads with molybdenum bisulfide based grease.
<b>CYLINDER BLOCK</b>					
Type	Dry type (single piece)				
Bore 102-04, 103-06, M20	64 (2.52")	64.00-64.019 (2.5197-2.5204")	64.2 (2.5276")	65.2 (2.5669")	Over size (0.5, 1.0) (.02, .04")
Bore 102-05, 103-07	67 (2.6378")	67.00-67.019 (2.6378-2.6385")	67.2 (2.6456")	68.2 (2.6850")	
Distortion of upper face of cylinder block		less than 0.05 (.002")	0.12 (.0047")		
<b>MAIN REVOLVING SYSTEM</b>					
<b>PISTON</b>					
Skirt diameter (longer diameter) 102-04, 103-06, M20	64 (2.52")	63.948-63.963 (2.5176-2.5182")		63.7 (2.5079")	Over size (0.5, 1.0) (.02, .04")
Skirt diameter (longer diameter) 102-05, 103-07	67 2.6378	66.9375-66.9525 (2.6353-2.6359")		66.7 (2.6260")	Over size (0.5, 1.0) (.02, .04")
Clearance to cylinder 102-04, 103-06, M20		0.038-0.072 (.0015-.0028")		0.25 (.010")	20°C
Clearance to cylinder 102-05, 103-07		0.048-0.082 (0.0019-0.0032)		0.25 (.010")	20°C
Inside diameter of piston pin	19 (.748")	18.998-19.002 (.7480-.7481")			
Piston pin hole-to-pin clearance		-0.004 +0.004 (-.00016 +.00016")		0.02 (.0008")	
<b>PISTON PIN</b>					
Outer diameter of pin	19 (.748")	18.998-19.002 (.7480-.7481")			
Small end bush-to-pin clearance		0.013-0.028 (.0005-.0011")		0.1 (.004")	Oil clearance
<b>PISTON RING</b>					
Piston ring gap:					
No. 1 ring		0.13-0.25 (.0051-0.01")		1.0 (.04")	
No. 2 ring		0.10-0.22 (.004-0.009")			
Oil ring		0.10-0.30 (.004-.012")			

Inspection items	Standard Dimension	Standard Value	To Be Repaired	Allowable Limit	Remarks	
<b>PISTON RING (Continued)</b>						
Piston ring groove-to-ring clearance						
No. 1 ring		0.06-0.1 (.0024-.004")		0.25 (.010")		
No. 2 ring		0.05-0.09 (.0020-.0035")				
Oil ring		0.02-0.06 (.0008-.0024")		0.15 (.006")		
Ring width						
No. 1 ring	1.5 (.059")	1.47-1.49 (.0579-.0587")			Over size (0.5, 1.0) (.020, .04")	
No. 2 ring	1.5 (.059")	1.47-1.49 (.0579-.0587")				
Oil ring	3 (.118")	2.97-2.99 (.1169-.1177")				
<b>CONNECTING ROD</b>						
Twist between small and large end holes (per 100mm)		less than 0.08 (.00315")	0.2 (.008")			
Straightness at 100mm between small and large end hole		less than 0.05 (.002")	0.15 (.006")			
Front-to-rear clearance between connecting rod and crank pin		0.1-0.3 (.004-.012")		0.7 (.028")		
Connecting rod metal-to-crank pin clearance		0.031-0.079 (.0012-.0031")		0.2 (.008")	Oil clearance	
Crush height of large end bearing		-0.01-+0.03 (-.0004-+.0012")			300kg (661.4lbs)	
Connecting rod bearing (inner diameter x width)	35 x 14.5 (1.378 x 0.571")					
Connecting rod bolt torque kg.m		2.1-2.6 (15.2-18.8lbs/ft)				
Weight difference with piston gram		less than 10				
Crush height of small end bush		-0.013-+0.05 (-.0005-+.002")			300kg (661.4lbs)	
<b>CRANKSHAFT</b>						
Diameter of journal	3 Cyl.		2Cyl.		Under size (0.25,0.5) (.01, .02")	
	No. 1, 2	No.1	43 (1.693")	42.964-42.975 (1.6915-1.6919")		42.9 (1.689")
	No. 3	No.2	46 (1.811")	45.964-45.975 (1.8096-1.8100)	45.9 (1.807")	
Diameter of pin			35 (1.378")	34.964-34.975 (1.3765-1.3770")	34.9 (1.374")	Same to above
Roughness, main journal and crank pin		1.6Z				
Crankshaft deflection			less than 0.03 (.0012")	more than 0.06 (.0024")		
Axial play of crankshaft			0.1-0.3 (.004-.012")		0.5 (.020")	



Inspection items	Standard Dimension	Standard Value	To Be Repaired	Allowable Limit	Remarks
<b>CRANKSHAFT (Continued)</b>					
O.D x I.D. of bush (journal metal)	47 x 43 (1.85 x 1.69")				Under size (0.25, 0.5) (.01, .02")
Crush height of bush (journal metal)		0.05-0.09 (.002-.0035")			500kg (1102.3lbs)
Clearance between crankshaft and journal metal (bush)		0.035-0.088 (.0014-.0035")		0.2 (.008")	Oil clearance
O.D. x I.D. of center bearing	47 x 43 (1.85 x 1.69")				Under size (0.25, 0.5) (.01, 0.2")
Clearance between crankshaft journal and center bearing		0.035-0.088 (.0014-.0035")		0.2 (.008")	Oil clearance
Crush height of center bearing	43 (1.693")	+0.015-+0.055 (+.0006-+.0022")			300kg (661.4lbs)
Crush height of center bearing	46 (1.811")	0-+0.055 (0-+.0022")			300kg (661.4lbs)

### VALVE SYSTEM

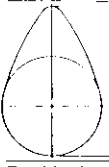
#### CAMSHAFT

 <p>Height of cam <b>PB126</b></p>	For intake/exhaust		26.565-26.620 (1.0459-1.0480")		26.1 (1.028")	
	For injection pump		34.48-34.52 (1.3575-1.3591")		34.3 (1.389")	
	For feed pump		27.9-28.0 (1.0984-1.1024")		27.0 (1.063")	
Backlash of cam gear			0.08 (.0031")		0.25 (.010")	

#### VALVE

Diameter of intake valve stem			5.960-5.975 (.2346-.2352")		5.9 (.2323")	
Diameter of exhaust valve stem			5.940-5.955 (.2339-.2344")		5.9 (.2323")	
Clearance between valve stem and valve guide	Inlet		0.025-0.052 (.001-.002")		more than 0.2 (.008")	
	Exhaust		0.045-0.072 (.0018-.0028")		more than 0.25 (.010")	
Thickness of valve		1.0 (.04")	0.925-1.075 (.0364-.0423")		0.5 (.020")	
 <p><b>PB127</b></p>						
Valve clearance (intake/exhaust)			0.2 (.008")	0.5 (.020")		When cold
Valve spring	Spring strength (at 28.3mm compressed length) kg		6.9 (15.21lbs)		6.0 (13.2lbs)	
	Free length		33 (1.299")		31.5 (1.240")	
	Squareness	 <p><b>PB128</b></p>	less than 1.0 (.04")		1.2 (.05")	

Inspection items		Standard Dimension	Standard Value	To Be Repaired	Allowable Limit	Remarks
<b>VALVE (Continued)</b>						
Inlet valve timing	Open-Before T.D.C.	13°				
	Close-After B.D.C.	43°				
Exhaust valve timing	Open-Before B.D.C.	43°				
	Close-After T.D.C.	13°				
<b>PUSH ROD</b>						
Overall length		146 (5.748")	145.6-146.4 (5.732-5.764")			
Outer diameter		6.3 (.248")				
<b>ROCKER ARM</b>						
Wear. rocker arm shaft		11.66 (.459")	11.65-11.67 (.4587-.4594")		11.57 (.4555")	
Clearance between rocker arm and shaft			0.032-0.068 (.0013-.0027")		0.2 (.008")	Oil clearance

## LUBRICATION SYSTEM

<b>OIL PUMP</b>						
Oil pressure switch operating pressure (kg/cm <sup>2</sup> ) (psi)		0.3 (4.27)	0.2-0.4 (2.844-5.688)			
Relief pressure (kg/cm <sup>2</sup> ) (psi)			3-5 (42.66-71.1)			
Lubrication oil capacity (lit) 2 Cyl. 3 Cyl.		2.1 2.8				
Tip clearance (rotor-to-vane)			0.01-0.15 (.0004-.006")		0.25 (.010")	
Side clearance (rotor-to-cover)			0.1-0.15 (.004-.006")		0.2 (.008")	

## FUEL SYSTEM

<b>INJECTION PUMP (102-04), (102-05)</b>		
Inspection items		Standard Dimension
Type		131017420
Diameter of plunger		4.5
Stroke of plunger		6
Injection Timing	B.T.D.C.	24.5-26.5
	Piston movement B.T.D.C.	3.786-4.411
Injection Timing	B.T.D.C.	26.5-28.5
	Piston movement B.T.D.C.	4.411-5.078

<b>INJECTION PUMP (103-06), (103-07)</b>		
Type		131017390
Diameter of plunger		4.5
Stroke of plunger		6
Injection Timing	B.T.D.C.	25.5-27.5
	Piston movement	4.093-4.739
Type		131017340
Diameter of plunger		4.5
Stroke of plunger		6
Injection Timing	B.T.D.C.	26.5-28.5
	Piston movement	4.411-5.078
Injection Timing	B.T.D.C.	24.5-26.5
	Piston movement	3.786-4.411

Inspection items	Standard Dimension	Standard Value	To Be Repaired	Allowable Limit	Remarks
<b>INJECTION NOZZLE</b>					
Type	093500-2240 (Part No. 131406340)				
Injection pressure kg/cm <sup>2</sup> (psi)	120 (1706)	115-125 (1635.3-1777.5)			
Angle of injection direction	4°				
<b>COOLING SYSTEM</b>					
<b>COOLING</b>					
Cooling method	Water cooled, forced circulation				
Thermostat open temperature (°C)	75	73-77			
Thermostat full-open temperature (°C)	87				
Pump discharge (lit/min) (at 2500rpm engine speed at cold)	40				
<b>ELECTRICAL SYSTEM</b>					
<b>STARTER MOTOR</b>					
Type	M003T32589 (Part No. 185086370)				
No. of teeth of pinion gear	8				
Shifting method of pinion	Magnetic				
Wear of commutator diameter	32 (1.26")			31 (1.22")	
Stepped wear of commutator		0.05 (.002")	0.4 (.016")		
Bending allowance of armature shaft			0.08 or more (.003")		
Length of brush	17 (.63")			11.5 (.45")	
Spring force of brush (kg) (lbs)	1.95 (4.3)	1.66-2.24 (3.66-4.94)		0.9 (1.98)	
<b>ALTERNATOR</b>					
Type	GP8146 (Part No. 185046210)				
Bend of rotor shaft			0.07 (.0028")		
<b>REGULATOR</b>					
Type	RS5101 (Part No. 185516060)				
Regulating voltage	14.5	14-15			

# SECTION IX

## Recommended Torque Tensions for 102-04, 102-05, 103-06, 103-07, 103-09, 103-10, Perama M20, M25, M30

Tensions kgf m (lbf ft)

COMPONENT	103-09/10, M25/M30	102-04/05, 103-06/07, M20
Bearing holder bolts (Upper and Lower) .....	2.0-2.5(14-18)	2.0-2.5(14-18)
Bearing holder bolts (Bearing holder to cyl. BLOCK) ...	2.5-3.0(19-22)	2.5-3.0(19-22)
Rear plate bolts .....	4.7-5.5 (34-40)	1.3-1.7 (9-12)
Flywheel bolts .....	6.0-7.0 (43-51)	7.0-8.0 (51-58)
Connecting rod nuts .....	3.0-3.5 (22-25)	2.1-2.6 (15-19)
Suctionfilter bolts .....	0.9-1.3 (7-9)	0.9-1.3 (7-9)
Sump bolts .....	0.9-1.3 (7-9)	0.9-1.3 (7-9)
Crankshaft pulley nut .....	12-13 (87-94)	9-10 (65-72)
Cylinder head bolts .....	5.0-5.3 (36-38) oiled	3.5-4 (25-29)
Injection pump bolts .....	0.9-1.3 (7-9)	0.9-1.3 (7-9)
Injection pump nut .....	0.9-1.3 (7-9)	0.9-1.3 (7-9)
Rocker arm nuts .....	2.0-2.5 (15-19)	2.0-2.5 (15-19)
Head cover nuts .....	1.0-1.2 (7-9)	1.0-1.2 (7-9)
Cooling fan bolts .....	0.9-1.3 (7-9)	0.9-1.3 (7-9)
Oil pipe banjo bolts .....	1.0-1.3 (7-9)	1.0-1.3 (7-9)
Oil pan drain bolt .....	3.0-4.0 (22-29)	3.0-4.0 (22-29)
Injection nozzle .....	8.0-8.5 (58-62)	6-7 (43-51)
Injection pipe .....	2.0-2.5 (15-19)	2.0-2.5 (15-19)
Thermo switch .....	2.5-3.0 (19-22)	2.5-3.0 (19-22)
Oil pressure switch .....	1.5-2.0 (11-15)	1.5-2.0 (11-15)
Glow plug .....	1.5-2.0 (11-15)	1.5-2.0 (11-15)
Solenoid .....	1.5-2.0 (11-15)	1.5-2.0 (11-15)
Relief valve .....	6.0-7.0 (44-51)	6.0-7.0 (44-51)
Smokeset nut (max fuel) .....	2.0-2.5 (15-19)	2.0-2.5 (15-19)
Adjusting screw nuts .....	1.3-1.7 (7-12)	1.3-1.7 (7-12)



# SECTION X

## Perama - Extra Service Items

### M20/M25/M30

Hurth Gearbox  
 Lubrication of Jabsco Water Pump  
 Heat Exchanger Tube Stack  
 Engine Preservation  
 Lucas A127 - 55 amp Alternator

#### How to check the amount of lubricating oil in the Hurth reverse gearbox

- 1 Release and remove the dipstick from the top of the reverse gearbox (A).
- 2 Clean the dipstick and insert it into its position but do not engage the thread.
- 3 Remove the dipstick and check that the lubricating oil level is up to the groove (A1) in the dipstick. If necessary, add automatic transmission fluid, ATF type "A", through the dipstick hole to the correct level. Do not add too much oil.
- 4 Ensure that the sealing ring (A2) for the dipstick is not damaged. Fit the sealing ring and the dipstick to the reverse gearbox.

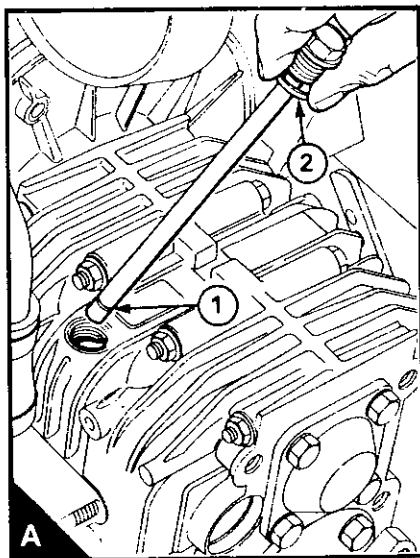

#### How to check/lubricate the impeller and the drive of the raw water pump

**Attention:** Do not loosen the drive housing of the raw water pump. The alignment of this housing has been carefully adjusted with a special alignment tool.

- 1 Ensure that the seacock is closed.
- 2 Disconnect the hose connections at the pump.
- 3 Remove the four setscrews which fasten the pump to its drive housing. Remove the pump.
- 4 Clean and inspect for wear the drive components of the pump. Renew the drive adaptor and/or the pump, if necessary.

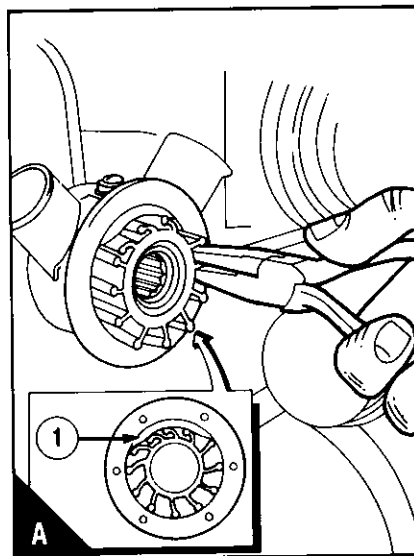

- 5 Release the six screws which fasten the end plate of the raw water pump and remove the plate.
- 6 Inspect the rubber impeller for excessive wear or for damage and renew it, if necessary. To remove the impeller, remove the rubber end cap and then pull the impeller from the shaft. Apply Marfak 2HD grease to the blades of the new impeller and fit the impeller into the housing with the blades bent anticlockwise (A). Fit the rubber end cap.

- 7 Clean the contact surfaces of the pump body and the end plate. Apply jointing compound to a new joint and fit it to the body with the wide area of the joint over the eccentric plate (A1) in the body. Fit the end plate and tighten the end plate screws.
- 8 Apply a high melting point grease (for example Shell Alvania R2) to the drive housing and to the drive components.
- 9 Fit the pump to its adaptor plate with a new joint between the pump and the plate. Tighten the four pump setscrews.
- 10 Connect the hose connections at the pump.
- 11 If necessary, open the seacock.
- 3 Operate the engine until it is warm. Then correct leakages of fuel, lubricating oil or air. Stop the engine and drain the lubricating oil from the sump.
- 4 Renew the canister of the lubricating oil filter.
- 5 Fill the sump to the full mark with new and clean lubricating oil and add POWERPART Lay-Up 2 to the oil to protect the engine against corrosion. If POWERPART Lay-Up 2 is not available, use a correct preservative fluid instead of the lubricating oil. If a preservative fluid is used, this must be drained and the lubricating oil sump must be filled to the correct level with normal lubricating oil at the end of the storage period.

#### How to clean the tube stack of the heat exchanger

If there are hard deposits or debris in the tubes, the best method to clean them is to use a non-caustic solution which is approved by the manufacturer.

If the deposits or the debris are soft, the tubes can be cleaned with a steel rod pushed through the tubes in the opposite direction to the water flow. Ensure that the rod does not damage the tubes.

#### To obtain access to the tube stack

- 1 Drain the circuits of the cooling system.
- 2 Loosen the support clips of the outlet pipe of the heat exchanger and disconnect the pipe from the front end cap of the heat exchanger.
- 3 Loosen the clips of the neoprene end caps and remove the caps. The tubes can now be checked for restriction and cleaned, if necessary.
- 4 Ensure that there is an equal protrusion of the tube stack through each end of the housing before the end caps are fitted.

#### Engine Preservation

The recommendations indicated below are designed to prevent damage to the engine when it is withdrawn from service for a prolonged period. Use these procedures after the engine is withdrawn from service. The instructions for the use of POWERPART products are given on the outside of each container.

#### Procedure

- 1 Completely clean the outside of the engine.
- 2 When a preservative fuel is to be used, drain the fuel system and fill it with the preservative fuel. POWERPART Lay-Up 1 can be added to the normal fuel to change it to a preservative fuel. If preservative fuel is not used, the system can be completely filled with normal fuel but the fuel must be drained and discarded at the end of the storage period together with the fuel filter canister.
- 6 Drain the coolant circuit. In order to protect the cooling system against corrosion, it is necessary to fill it with a coolant that has a corrosion inhibitor. If protection against frost is necessary, use an antifreeze mixture. If protection against frost is not necessary, use water with an approved mixture of corrosion inhibitor.
- 7 Operate the engine for a short period in order to circulate the lubricating oil and the coolant in the engine.
- 8 Close the seacock and drain the raw water cooling system. If a lubricating oil cooler is fitted to the Hurth reverse gearbox and protection against frost is necessary, disconnect the top hose at the cooler and inject 50ml (0.1 UK pint) of undiluted antifreeze into the cooler.
- 9 Remove the end plate from the raw water pump and lubricate the impeller and the inside of the pump with Marfak 2HD grease or glycerine. If necessary, glycerine can be put in the inlet connection of the pump but the engine must be turned to circulate the glycerine through the pump.
- Attention:** The raw water pump must never run in a dry condition because this can damage the impeller blades.
- 10 Remove the atomisers and spray POWERPART Lay-Up 2 into each cylinder bore. If this is not available, clean engine lubricating oil will give a degree of protection. Spray into the cylinder bores 140ml (0.25 pint) of lubricating oil divided evenly between the cylinders.
- 11 Slowly turn the crankshaft one revolution and then fit the atomisers, complete with new seat washers.
- 12 Remove the air filter or the induction cap. Spray POWERPART Lay-Up 2 into the induction manifold. Seal the manifold with waterproof tape.
- 13 Remove the exhaust pipe. Spray POWERPART Lay-Up 2 into the exhaust manifold. Seal the manifold with water proof tape.

- 14 Disconnect the battery. Then put the battery into safe storage in a fully charged condition. Before the battery is put into storage, protect its terminals against corrosion. POWERPART Lay-Up 3 can be used on the terminals.
- 15 Seal the vent pipe of the fuel tank or the fuel filler cap with waterproof tape.
- 16 Remove the alternator drive belt and put it into storage.
- 17 In order to prevent corrosion, spray the engine with POWERPART Lay-Up 3. Do not spray the area inside the alternator cooling fan.
- 18 If the transmission is not to be used for at least a year, fill the Hurth gearbox completely with its normal lubricating oil. This will have to be drained and the normal amount of new lubricating oil added when the engine is returned to service.

**Attention:** After a period in storage, but before the engine is started, operate the starter motor with the stop button pressed or with the engine stop control in the "stop" position until oil pressure is indicated. Oil pressure is indicated when the low pressure warning light is extinguished.

If the engine protection is done correctly according to the above recommendations, no corrosion damage will normally occur. Perkins are not responsible for damage which may occur when an engine is in storage after a period in service.

### Alternator A127 – 55 amp

#### – To remove and to fit

##### To remove

- 1 Disconnect the electrical connection.
- 2 Loosen the pivot fasteners of the alternator and the fasteners of the adjustment link.
- 3 Release all the belt tension and remove the belt.
- 4 Remove the adjustment link from the alternator and remove the pivot bolt(s). Make a note of the position of the washers and distance pieces to ensure that they are fitted correctly. Remove the alternator.

##### To fit

- 1 Put the alternator in position and assemble loosely the pivot fasteners and the adjustment link and its fasteners. Ensure that the washers and the distance pieces are fitted in their correct positions and that the alternator pulley is aligned to the crankshaft pulley within  $\pm 2.4\text{mm}$  ( $\frac{3}{32}\text{in}$ ).
- 2 Fit the drive belt and adjust the drive belt tension. Tighten the fasteners and check the tension again.
- 3 Connect the electrical connection.

##### To maintain

- 1 Ensure that the drive belt is not worn and that the belt tension is correct.
- 2 Keep the alternator clean. To clean the alternator, use a material which is damp with

kerosene or a special fluid used for this purpose. Ensure that the fluid does not enter the cover of the alternator.

- 3 Ensure that air can pass easily over the casing to keep it cool.

#### Fault diagnosis

The alternator is so designed that a flow of current indicated by no light at the warning light or a reading shown on an ammeter is enough indication that the system is in correct operation. If the system is in correct operation, no open circuit, voltage or current output checks need to be done on the installation unless:

- The warning light does not show when the alternator is stationary and the switch is in the "on" position or it shows a light when the alternator is in operation.
- No charge current is shown on the ammeter.
- The battery is discharged.
- The battery is hotter than normal which is an indication of loss of voltage control.

If one or more of the above symptoms occur, the procedure indicated below should be applied.

- 1 Ensure that the battery is in a fully charged condition.
- 2 Connect a moving-coil voltmeter of good quality, with a range of 0-50 volts, across the positive and negative terminals of the alternator. If an ammeter is not fitted in the electrical circuit, fit a moving-coil ammeter of good quality, with a range of 0-100 ampere, in the wire between the alternator and the positive terminal of the battery.
- 3 Turn the warning light switch to the "on" position (main switch on instrument panel) when the warning light should be illuminated.
- 4 Switch on a 10-15 ampere load, for example, lights, fans, etc..
- 5 Start the engine and operate it at a fast idle speed when either the warning light should be extinguished or the ammeter indicates a small change in the current in relationship to the engine speed.
- 6 Increase the engine speed for a moment to near maximum speed, when the charge current should be approximately 55 amperes (A127) for a 12 volt system.
- 7 Operate the alternator at approximately half speed (engine speed approximately 1800 rev/min) and remove the electrical load. The voltage should go up to 14 volts for a 12 volt system or 28 volts for a 24 volt system and then remain constant. At the same time the current reading should show a reduction.

If a fault is found, the alternator should be removed for test by a specialist.

The regulator is a sealed unit and a repair is not possible. If there is a regulator fault, the regulator must be renewed.

# SECTION XI

## Conversion Formulas

**TIGHTENING TORQUE TABLES**

Screw size	Bolt head identification marks as per grade	Coarse thread		Fine thread	
		Screw pitch (mm)	Tightening torque (kgf.cm)	Screw pitch (mm)	Tightening torque (kgf.cm)
M4	4T, 4.8	0.7	15~ 21		
	7T, 8T, 8.8		27~ 37		
	10T, 11T		36~ 50		
M5	4T, 4.8	0.8	29~ 41		
	7T, 8T, 8.8		50~ 70		
	10T, 11T		68~ 96		
M6	4T, 4.8	1.0	50~ 70		
	7T, 8T, 8.8		85~ 115		
	10T, 11T		120~ 160		
M8	4T, 4.8	1.25	130~ 170	1.0	155~ 205
	7T, 8T, 8.8		230~ 290		270~ 350
	10T, 11T		290~ 370		310~ 410
M10	4T, 4.8	1.5	260~ 340	1.25	290~ 370
	7T, 8T, 8.8		450~ 570		500~ 640
	10T, 11T		550~ 710		590~ 750
M12	4T, 4.8	1.75	380~ 480	1.25	440~ 560
	4T, 8T, 8.8		670~ 850		760~ 960
	10T, 11T		940~1,180		1,010~1,290
M14	4T, 4.8	2.0	640~ 820	1.5	710~ 890
	7T, 8T, 8.8		1,060~1,340		1,190~1,510
	10T, 11T		1,420~1,780		1,500~1,900
M16	4T, 4.8	2.0	880~1,120	1.5	930~1,170
	7T, 8T, 8.8		1,520~1,880		1,600~1,960
	10T, 11T		2,100~2,600		2,250~2,750
M18	4T, 4.8	2.0	1,160~1,440	1.5	1,340~1,660
	7T, 8T, 8.8		2,000~2,400		2,350~2,850
	10T, 11T		2,800~3,400		3,050~3,750
M20	4T, 4.8	2.5	1,470~1,830	1.5	1,750~2,150
	7T, 8T, 8.8		2,450~2,950		2,800~3,400
	10T, 11T		3,700~4,500		4,050~4,950

Material	SS41 S20C SGD41-D SWRM12	S45C	SCM435
	Bolt head marks		

0010

**TIGHTENING TORQUE TABLES**

Screw size	Bolt head identification marks as per grade	Coarse thread			Finethread		
		Screw pitch (mm)	Tightening torque		Screw pitch (mm)	Tightening torque	
			lbs-ft	N.m		lbs-ft	N.m
M6	4T, 4.8	1.0	3.6~5.1	4.9~6.9			
	7T, 8T, 8.8		6.1~8.3	8.3~11.3			
	10T, 11T		8.7~11.6	11.8~15.7			
M8	4T, 4.8	1.25	9.4~12.3	12.7~16.7	1.0	11.2~14.8	15.2~20.1
	7T, 8T, 8.8		16.6~21.0	22.6~28.4		19.5~25.3	26.5~34.3
	10T, 11T		21.0~26.8	28.4~36.3		22.4~29.7	30.4~40.2
M10	4T, 4.8	1.5	18.8~24.6	25.5~33.3	1.25	21.0~26.8	28.4~36.3
	7T, 8T, 8.8		32.6~41.2	44.1~55.9		36.2~46.3	49.0~62.8
	10T, 11T		39.8~51.4	53.9~69.6		42.7~54.3	57.9~73.6
M12	4T, 4.8	1.75	27.5~34.7	37.3~47.1	1.25	31.8~40.5	43.2~54.9
	7T, 8T, 8.8		55.7~61.5	65.7~83.4		55.0~69.5	74.5~94.1
	10T, 11T		68.0~85.4	92.2~116		73.1~93.3	99.1~127
M14	4T, 4.8	2.0	46.3~59.3	62.8~80.4	1.5	51.4~64.4	69.6~87.3
	7T, 8T, 8.8		76.7~96.9	104~131		86.1~109	117~148
	10T, 11T		103~129	139~175		109~137	147~186
M16	4T, 4.8	2.0	63.7~81.0	86.3~110	1.5	67.3~84.6	91.2~115
	7T, 8T, 8.8		110~136	149~184		116~142	157~192
	10T, 11T		152~188	206~255		163~199	221~270
M18	4T, 4.8	2.0	83.9~104	114~141	1.5	96.9~120	131~163
	7T, 8T, 8.8		145~174	196~235		170~206	230~279
	10T, 11T		203~246	275~333		221~271	299~368
M20	4T, 4.8	2.5	106~132	144~179	1.5	127~156	172~211
	7T, 8T, 8.8		177~213	240~289		203~246	275~333
	10T, 11T		268~326	363~441		293~358	397~485

Material	SS41	S45C	SCM435
	SGD41-D SWRM12		
Bolt head marks			

**CONVERSION TABLES**

kgf-m lbs/ft, (N.m)

	.0	.1	.2	.3	.4	.5	.6	.7	.8	.9
0		0.723 (0.98)	1.45 (1.96)	2.17 (2.94)	2.89 (3.92)	3.62 (4.9)	4.34 (5.88)	5.06 (6.86)	5.79 (7.84)	6.51 (8.82)
1	7.233 (9.8)	7.96 (10.8)	8.7 (11.8)	9.4 (12.7)	10.1 (13.7)	10.8 (14.7)	11.6 (15.7)	12.3 (16.7)	13.0 (17.6)	13.7 (18.6)
2	14.5 (19.6)	15.2 (20.6)	15.9 (21.6)	16.6 (22.5)	17.4 (23.5)	18.1 (24.5)	18.8 (25.5)	19.5 (26.5)	20.3 (27.4)	20.9 (28.4)
3	21.7 (29.4)	22.4 (30.4)	23.1 (31.4)	23.9 (32.3)	24.6 (33.3)	25.3 (34.3)	26.0 (35.3)	26.8 (36.3)	27.5 (37.2)	28.2 (38.2)
4	28.9 (39.2)	29.7 (40.2)	30.4 (41.2)	31.1 (42.1)	31.8 (43.1)	32.5 (44.1)	33.3 (45.1)	34.0 (46.1)	34.7 (47.0)	35.4 (48.0)
5	36.2 (49.0)	36.9 (50.0)	37.6 (51.0)	38.3 (51.9)	39.1 (52.9)	39.8 (53.9)	40.5 (54.9)	41.2 (55.9)	42.0 (56.8)	42.7 (57.8)
6	43.4 (58.8)	44.1 (59.8)	44.8 (60.8)	45.6 (61.7)	46.3 (62.7)	47.0 (63.7)	47.7 (64.7)	48.5 (65.7)	49.2 (66.6)	49.9 (67.6)
7	50.6 (68.6)	51.4 (69.6)	52.1 (70.6)	52.8 (71.5)	53.5 (72.5)	54.2 (73.5)	55.0 (74.5)	55.7 (75.5)	56.4 (76.4)	57.1 (77.4)
8	57.9 (78.4)	58.6 (79.4)	59.3 (80.4)	60.0 (81.3)	60.8 (82.3)	61.5 (83.3)	62.2 (84.3)	62.9 (85.3)	63.7 (86.2)	64.4 (87.2)
9	65.1 (88.2)	65.8 (89.2)	66.5 (90.2)	67.3 (91.1)	68.0 (92.1)	68.7 (93.1)	69.4 (94.1)	70.2 (95.1)	70.9 (96.0)	71.6 (97.0)

○ For example

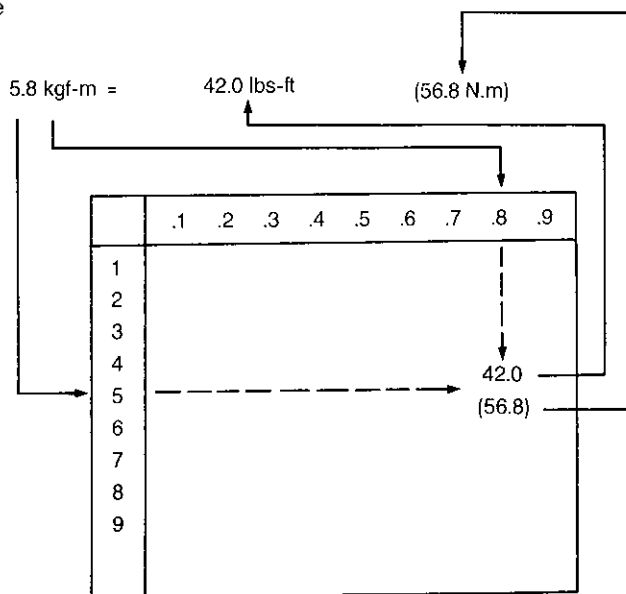

1mm	=0.03937in.
1m	=3.28084ft.
1kgf-m	=7.233lbs-ft
1kfg-m	=9.8N.m
1kg/cm <sup>2</sup>	=14.22psi.
1kg	=2.20462lbs

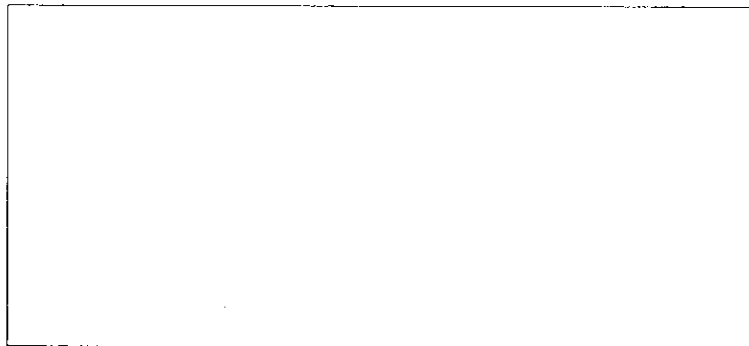

**Perkins Engines Company Limited**

Peterborough PE1 5NA  
Telephone 01733 583000  
Fax 01733 582240